



SEASON 2026-27

[View all assets](#)



Symbiosis, n.

[sim-bee-oh-sis, -bahy-]

A relationship between multiple objects in which each depends on the others, resulting in a single system that reaches optimal efficiency.

It's a quest that has no end. Match the right board to the conditions and contours. Enhance the experience with the right stance, proper edges, and optimal wax. Amplify the moment with the right combination of turns, airs, and tempo.

The snowboard is our instrument. Selecting one that lets you play your own song is the first step to finding harmony in the mountains. Forty years in, I still ride for that feeling. It starts with a loose plan of descent, but the best music happens when the board takes over and the mind goes quiet. In these moments, the board becomes an extension of the body and the line between fantasy and reality disappears.

Finding this place begins with honesty about your ability and intent, then choosing the instrument that lets your song come through. I subscribe to the philosophy of "change your board, change your mountain." I'm an explorer of multiple tempos and turns; my instrument varies with snow and terrain.

Others are disciples of one - like my kids, Mia and Cass. Their hyper-commitment to progression, learning new tricks, and hitting new lines on the daily requires their board to be a constant. It frees their focus to unlock new performance levels with a deep understanding of how it will handle while they thread the line between success and failure.

Less talked about, but equally important, is your clothing. You know you've nailed it when it becomes an afterthought. But we all know the other side of that coin: being too hot, too cold, or soaked through can become all-encompassing.

Full symbiosis means nailing the whole kit, from what's under your feet to what's on your back. That's why we built Jones Outerwear. Five years in, our most complete outerwear line reflects our unwavering ode to progression. Test, tweak, repeat. Stagnation is not an option.

The lessons learned from a lifetime in serious mountains have been invaluable in this process. We've all seen the lone rider charging a line in movies or magazines, but what people don't see is the teamwork it takes to make it happen.

The same is true of the products in the pages ahead. There are no shortcuts. We surround ourselves with the best designers and engineers, and we build with the most responsible factories and the cleanest materials we can source. We learn by doing, and we give it everything we have.

This is our new high point, a lifetime in the making.

A close-up photograph of a hand wearing a tan leather ski glove, firmly gripping a black ski pole. The hand is positioned in the center-left of the frame, with the pole extending vertically downwards. The background is a soft, out-of-focus white, suggesting a snowy or bright environment. The lighting is natural, highlighting the texture of the leather and the metallic sheen of the pole's grip.

JEREMY
JONES



Rooted in Adventure
Obsessed with Performance
Committed to our Planet

PROUD MEMBER



WE BELIEVE THERE IS A BETTER WAY

Our Design Ethos



Eco-Performance

We strive to make products with the least impact on the planet possible, but we trust our lives to our gear so we must value performance foremost. We test new materials and production processes to make sure we never sacrifice performance or durability just to make a product more responsibly. Durability is also critical as the longer gear lasts, the less waste that goes to the dump. This ECO-Performance design philosophy is the foundation upon which everything we make is made.

Responsibility

To make gear in the most responsible way possible, we strive to minimize the impact of our materials and manufacturing processes however we can. All of our snowboards, splitboards and outerwear contain recycled materials, and they always have. Our boards are also made in a factory that runs on 100% solar power, and the fabrics we use in our outerwear are Oeko-Tex and/or Bluesign® certified - the two leading responsible material certifications in the apparel industry.

Innovation

From our groundbreaking board shapes to our trailblazing outerwear designs, we never settle for anything less than game changing gear performance. By keeping an open mind to new gear concepts, materials and production processes we aspire to do things differently, and make innovative gear and outerwear that blends comfort, durability and industry leading responsible manufacturing practices with standard setting performance.

Manufacturing

Our network of factory partners helps us set new responsible manufacturing standards.



Solar power

As of May 2020, all Jones snowboards and splitboards are made with 100% solar power. Switching our snowboard and splitboard production to 100% solar made an 89% reduction in CO₂ compared to non-solar powered production.



Socially responsible factories

All snowboards and splitboards are Fair Trade certified, an industry first. All of our outerwear and apparel is made in socially responsible factories that are Business Social Compliance Initiative (BSCI) and Worldwide Responsible Accredited Production (WRAP) certified. These certifications guarantee that the people who make our outerwear and apparel receive fair salaries and work in a safe and clean working environment.



Committed to our Code-of-Conduct

All of our factory partners have signed our Code Of Conduct that guarantees the people who make our gear are treated fairly and have safe working conditions.

2026-27 Hardgoods Highlights

NEW MODELS



Triple the choice: Expanding our FASE® binding collection

After the record-breaking debut of the Mercury FASE® binding, two new models join the line for winter 2027. The Zenith FASE® delivers power and ultra-fast response for advanced to expert-level riders, while the Nebula FASE® enhances tweakability and underfoot feel with a playful all-mountain freestyle flex.

NEW MODELS



Unleashed: The all-new Howler Split

The Howler has already earned a loyal following as the creative freerider's go-to snowboard. New for this season, the Howler Split gives riders the freedom to fuse freestyle with full-throttle freeriding while unlocking new terrain in the backcountry.

NEW SHAPE



Ride hard, tweak harder: New Tweaker 2.0 shapes

Ushering in the second generation of our team's go-to freestyle decks, the Tweaker 2.0 series was born in the park and built for the mountains. A redesigned true twin shape, 3D profile, and PRO construction option make this our most freestyle-focused, all-mountain-ready series yet.

NEW GRAPHICS

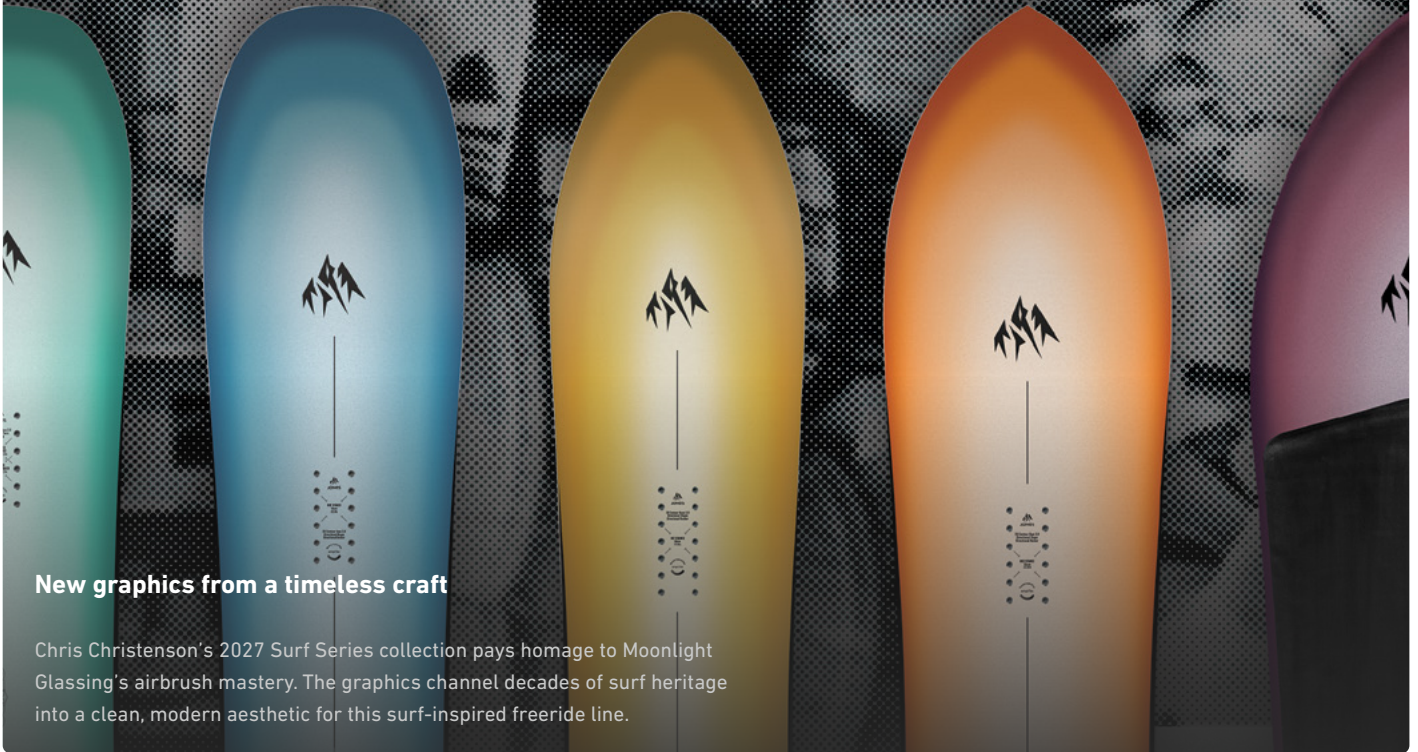

New graphics from a timeless craft

Chris Christenson's 2027 Surf Series collection pays homage to Moonlight Glassing's airbrush mastery. The graphics channel decades of surf heritage into a clean, modern aesthetic for this surf-inspired freeride line.

NEW MODEL



Introducing the TwinCraft: Float, pop, spin, repeat

The all-new, powder-focused directional twin with freestyle at its core. The new addition to the Surf Series combines an extra-wide waist width with a shorter running length and a tighter sidecut. It's made for effortless float, chucking tricks and nimble turns in powder - whichever way you point it.

NEW SHAPE

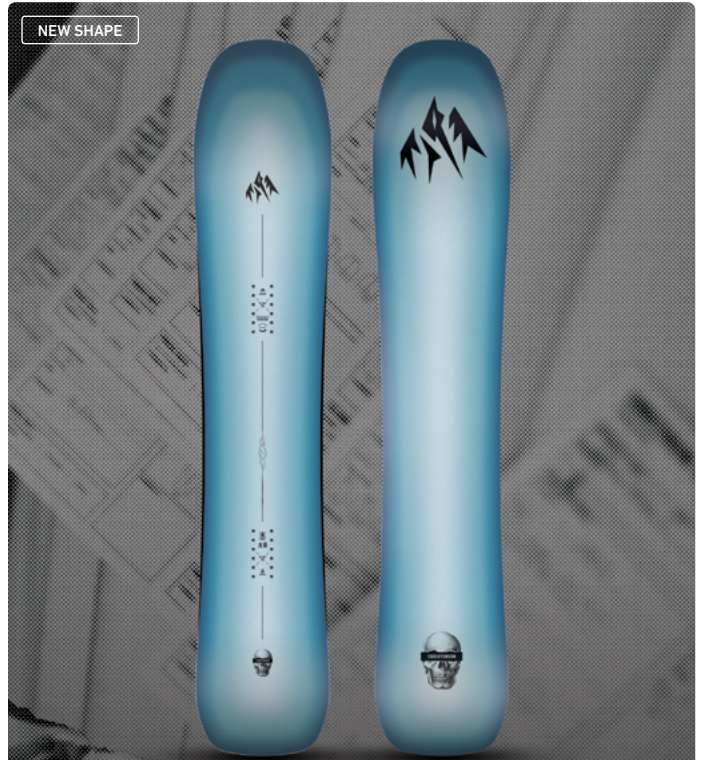

Mind Expander 2.0: The cult favorite, reimaged

The cornerstone of the Surf Series enters a new era with a full redesign. A new shape, camber profile and dual radius sidecut ensure the Mind Expander 2.0 retains the legendary float of its predecessor, while delivering improved stability and handling for creative all-mountain freeriding.

2026-27 Softgoods Highlights

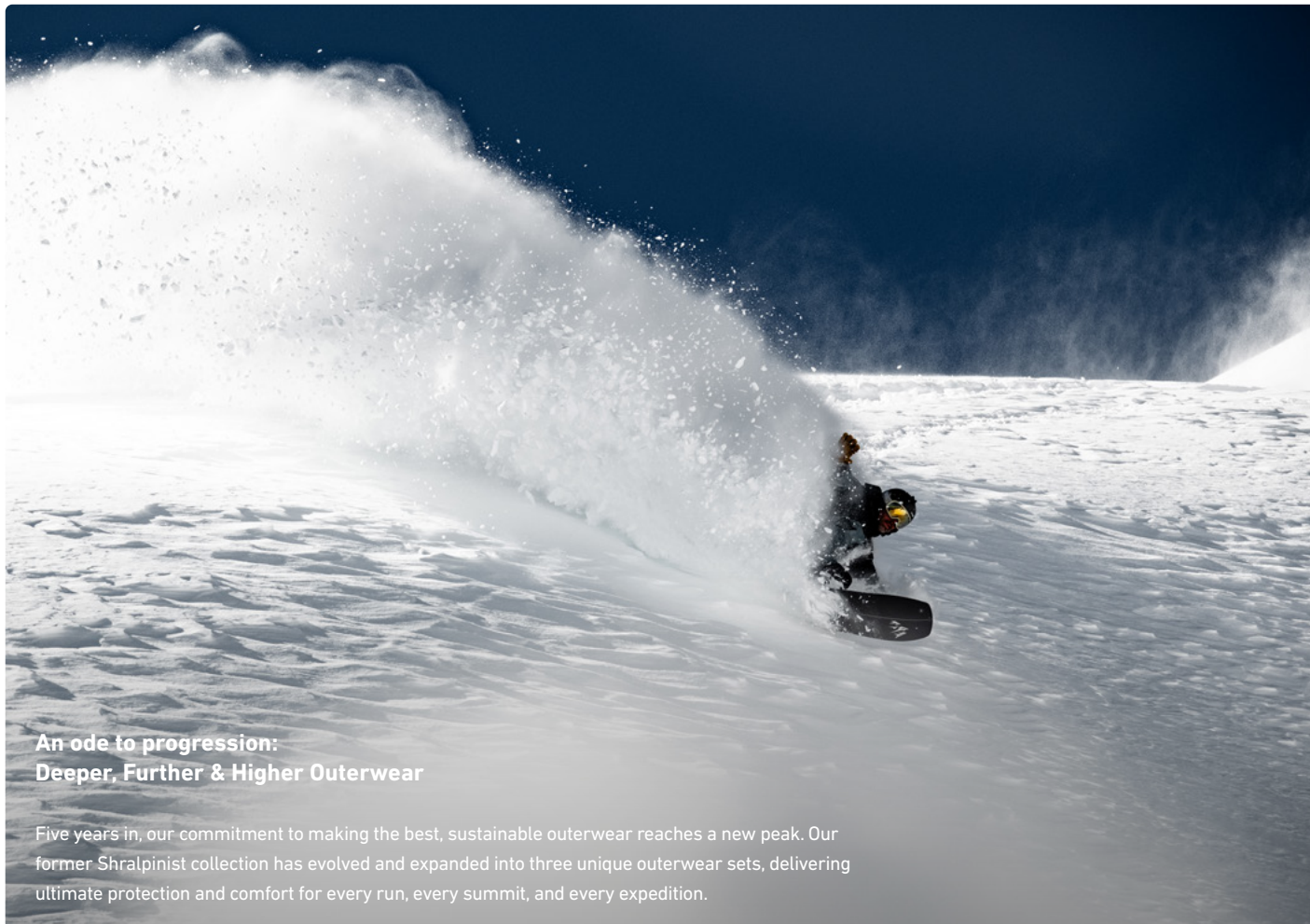

An ode to progression: Deeper, Further & Higher Outerwear

Five years in, our commitment to making the best, sustainable outerwear reaches a new peak. Our former Shralpinist collection has evolved and expanded into three unique outerwear sets, delivering ultimate protection and comfort for every run, every summit, and every expedition.

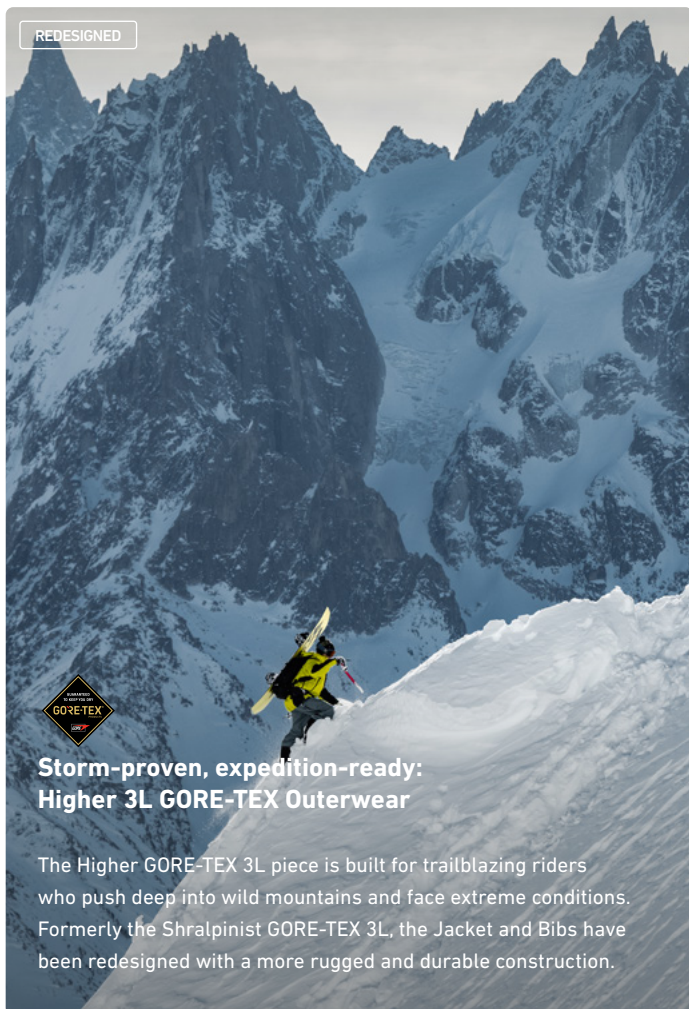

Storm-proven, expedition-ready: Higher 3L GORE-TEX Outerwear

The Higher GORE-TEX 3L piece is built for trailblazing riders who push deep into wild mountains and face extreme conditions. Formerly the Shralpinist GORE-TEX 3L, the Jacket and Bibs have been redesigned with a more rugged and durable construction.



Made to go far: Further 3L Stretch Outerwear

The former Shralpinist Stretch 3L Jacket and Bibs have been redesigned and renamed for 2027. Featuring new jacket pocket placement and a switch from bibs to pants, the Further 3L Stretch Jacket and Pants deliver supreme comfort and all-conditions protection.

NEW MODELS

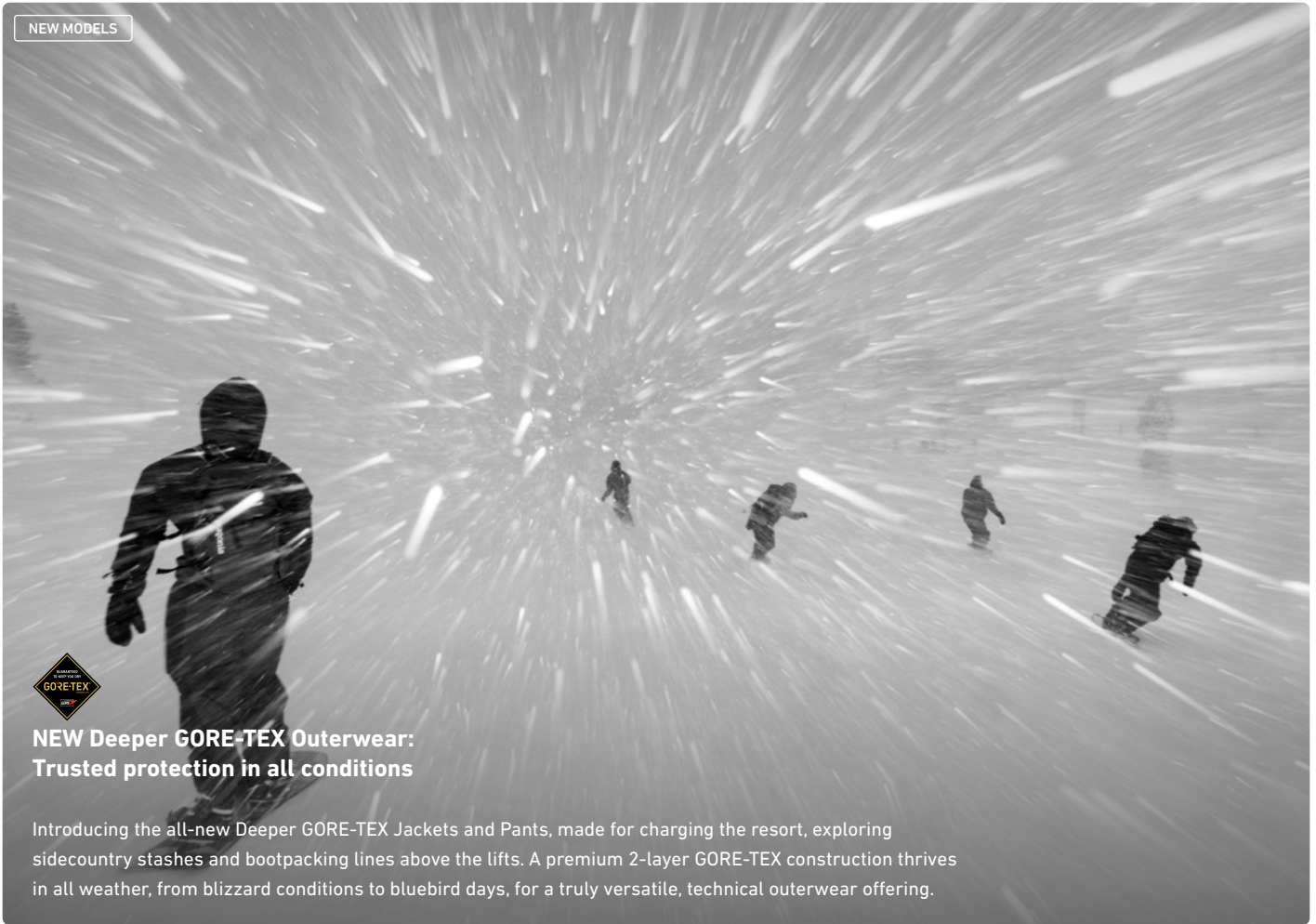

**NEW Deeper GORE-TEX Outerwear:
Trusted protection in all conditions**

Introducing the all-new Deeper GORE-TEX Jackets and Pants, made for charging the resort, exploring sidecountry stashes and bootpacking lines above the lifts. A premium 2-layer GORE-TEX construction thrives in all weather, from blizzard conditions to bluebird days, for a truly versatile, technical outerwear offering.

NEW MODEL



**When winter bites:
NEW Max Re-Up 750+ Down Hooded Jacket**

Maximum warmth meets packable performance in our new insulated jacket - the warmest we've ever made. Premium high-loft 750+ fill RENU recycled down delivers next-level protection from the cold, whether you're summiting or back at basecamp.

REDESIGNED



**Every layer counts:
Redesigned fleece collections**

From technical, performance-driven layering to soft, cozy pieces you can wear on the mountain or relax in after a day of riding, our fleece collections have been redesigned with updated materials for improved comfort, warmth, and breathability.

Triple The Choice.



MERCURY FASE®



NEBULA FASE®



ZENITH FASE®



The FASE® Binding System



The next-generation two-strap snowboard binding system

The FASE® Fast Entry System enhances the locked-in feel of traditional two-strap bindings, combined with an ultra-fast strapping-in process, while delivering unmatched high performance, all-day comfort, and a natural board feel.

Key advantages of the FASE® System

- Effortless fast entry and exit
- Enhanced locked-in feel
- True two-strap performance
- Instant on-the-fly adjustments
- Trusted by riders in every terrain and condition
- Mountain-proof durability with lifetime warranty
- Minimal weight and footprint
- Compatible with all snowboard boots

Learn more about the FASE® System on

jonessnowboards.com/fase

How do FASE® bindings work?

FASE® builds on the two-strap design by introducing three key ingredients. Each component plays a role, but it's the sum of these parts that makes the process of getting in and out of FASE® bindings so fast and intuitive.



The AutoBack

The key to the revolutionary FASE® Fast Entry System, the AutoBack, allows for hands-free entry into the binding. This intuitive design automatically closes as the boot enters the binding and opens when you lift your boot out. The AutoBack also folds flat for skating, chairlifts, and storage.

The FastStrap

An innovative long ankle ladder that remains connected for ultra-fast, one-handed strapping-in. With a classic ratchet design to fine tune ankle strap tension, the FastStrap complements the AutoBack's automatic closure system so riders can strap-in faster than ever before.

The Locked-In Toe Strap UPDATED

Simply set it and forget it. Designed to remain in position to complement the Fast Entry System, the Locking Slap Ratchet 2.1 and unique tri-toothed ladder allow you to 'set it and forget it' or make easy on-the-fly fit adjustments. Updated buckle system with an improved auto-lock mechanism.

“

Mercury FASE bindings set a new performance standard. They offer true board feel, all day comfort with fast entry and exit.



JEREMY JONES

“

The control and response I had in the FASE bindings was unmatched this past winter. The board feel they provided from edge to edge made me feel super confident in steep and technical terrain!



MARISSA KRAWCZAK

“

FASE, Fast Entry! On the first day of riding, I forgot I was on a new binding. The responsiveness and control is amazing.



VICTOR DE LE RUE

“

I got to really like the FASE bindings after a winter in them. Hardly had to adjust my strap-in process because it's so seamless, and I just got to be even faster rolling around the mountain all day.



HARRY KEARNEY



FASE® System Weight

The FASE® Fast Entry System is engineered to integrate seamlessly into Jones bindings. The mechanism itself weighs only 40 g (1.4 oz). In size Medium, the Jones Mercury FASE® weighs 870 g (30 oz), fully comparable to the Mercury without FASE® and other premium two-strap models.



FASE® System Volume

The system adds no noticeable volume underfoot. In size Medium, the Jones Mercury FASE® measures 294 mm in length, identical to the Jones Mercury without FASE® and equal to any standard binding footprint.

Binding Technology Overview

ZENITH FASE® NEW MODEL



AsymCore Carbon Highback

Stiff, carbon-injected highback built for maximum power transmission and ultra-fast response. Pre-loaded with more forward lean, a fully extended upper wing to wrap your boot, and our most responsive Asym Spine for turning power.



Fusion+ XR-C Baseplate

Carbon-injected, asymmetric, low-profile XR-C Baseplate delivers maximum response, power, and lightweight precision. Built on the Fusion+ Pad, a premium three-layer blend of EVA and TPU, for optimal impact protection and vibration absorption for hard-charging riders.



VertEx Ankle Strap

Two-part asymmetric strap blends soft PU foam with a structured VertEx Spine, providing a connected fit with immediate response and power transfer.

NEBULA FASE® NEW MODEL



AsymFlite Highback

Mid-soft highback delivers a playful, freestyle-friendly flex and shape. The Asym Spine delivers support and power where you need it, while the softer internal side provides the freedom to slash and tweak.



D-Fuse XR Baseplate

Asymmetric, low-profile XR Baseplate, made from a glass-nylon composite, delivers quick response and precise board control. A plush PU foam D-Fuse Pad cradles the baseplate for natural board feel and impact absorption that thrives in freestyle-friendly terrain.



SensiFlex Ankle Strap

Single-piece SensiFit Ankle Strap provides support through the centre with softer edges to conform around any boot for a truly connected and playful feel.

MERCURY FASE®



AsymFlex Highback

Mid-stiff highback features an asymmetric outline with an extended upper wing for enhanced turn performance. The softer internal side lets you tweak while the Asym Spine delivers more power to the external side.



Fusion XR Baseplate

Asymmetric, low-profile XR Baseplate, made from a glass-nylon composite, provides instant response for all-mountain charging. The Fusion Pad's innovative three-layer TPU and EVA blend ensures dynamic impact protection and vibration absorption across any terrain.



DualFlex Ankle Strap

Asymmetric design features a stiff TPU core for lightning-fast response and softer TPU edges for all-day comfort and universal boot fit.

ZENITH FASE® NEW MODEL

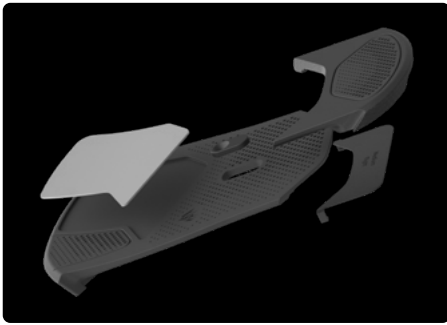

ImpactCush+ Footbed

Engineered for powerful riding in demanding terrain, the ImpactCush+ Footbed uses higher-density foam to deliver quicker edge response and dialed-in precision. The sliding footbed integrates seamlessly with the FASE® System and features a 3° cant for enhanced turn response.

NEBULA FASE® NEW MODEL



ImpactPulse Footbed

Built for all-day comfort and functionality, the ImpactPulse Footbed features a 3° cant for a more natural stance and PU foam for superior vibration damping and impact absorption. Designed for the FASE® System, its sliding pattern enables smooth entry and exit with locked-in lateral grip when strapped in.

MERCURY FASE®

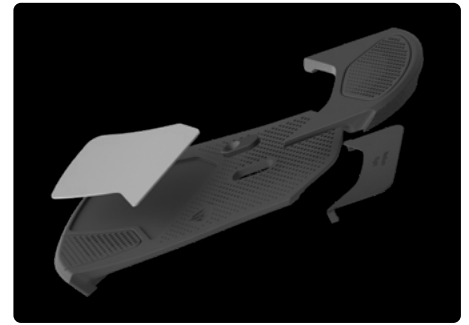

ImpactCush Footbed

Designed for all-day comfort, the ImpactCush Footbed soaks up board chatter in rough terrain and dampens the impact of heavy landings. The sliding footbed seamlessly integrates with the FASE® System and features a 3° cant for enhanced turn response.

ALL MODELS



Adaptive Fit Toe Strap

The Adaptive Fit Toe Strap features a flexible exterior outline that shapes to your boot, a denser center spine that ensures a secure lock, and a textured interior surface that grips onto your boot.



Alloy Buckles

High-grade aluminum buckles engineered for maximum durability.



LSR 2.1 Auto-Lock Toe Buckle UPDATED

Designed to stay in position to complement the Fast Entry System, the Locking Slap Ratchet 2.1 and unique tri-toothed ladder remain securely fastened while still allowing easy on-the-fly fit adjustments. Updated for 2027 with an improved auto-lock mechanism.



Universal Mounting Disk

All Jones bindings include a mounting disk compatible with traditional 4x4 inserts, 2x4, and the EST/Channel mounting system.



LKT_22 LAB1 // 39°11'N Δ 120°14'W

FAST
SYSTEM

Zenith FASE®

NEW MODEL

UNISEX

The next-gen powerhouse binding

Powerful, max response, fast entry

Ideal for expert-level freeriding and high-speed carving

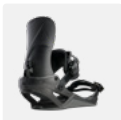

BLACK CARBON

The Zenith FASE® is a next-gen, carbon-injected binding that delivers instant response, maximum power transfer, and the locked-in feel of a two-strap design, combined with the FASE® Fast Entry System. Developed in collaboration with our Pro Team, it's engineered for advanced to expert-level riders seeking a zero-compromise performance binding in the most demanding terrain.

Terrain



Personality/Flex

Stiff & powerful - 5/5

Weight per pair:

1.8 kg (size M)

- FASE® Fast Entry System for rapid, effortless entry and exit
- Stiff flex for maximum and power transmission and precision
- Fusion® XR-C carbon-injected baseplate for lightning-fast response

Features

Fusion® XR-C Baseplate NEW

ImpactCush® Footbed NEW

AsymCore Carbon Highback NEW

VertEx Ankle Strap NEW

Adaptive Fit Toe Strap

Alloy Buckles

LSR 2.1 Auto-Lock Toe Buckle UPDATED

Universal mounting disk

Tool-less strap adjustment

Tool-less forward-lean adjustment

Mercury FASE®

UNISEX

The next-gen dynamic all-mountain binding

Versatile, responsive, fast entry

Ideal for all-mountain riding with confidence, control, and style

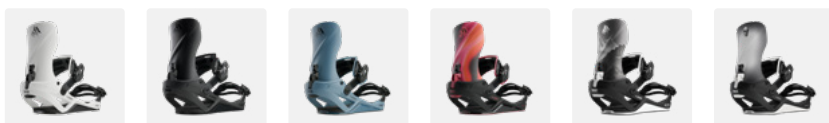

CLOUD WHITE

STEALTH BLACK

POLAR BLUE

BOREALIS BLACK/PINK

MTN BLACK/SILVER

BLACK SURF SERIES

Designed for all-terrain performance, the Mercury FASE® is a super versatile next-gen binding offering the locked-in feel, all-day comfort, and precise response of a traditional two-strap binding combined with the FASE® Fast Entry System. Powerful enough for demanding lines but equally adept at creative riding across the resort, the Mercury FASE® is built for confident riders who shred everything.

- FASE® Fast Entry System for rapid, effortless entry and exit
- Mid-stiff flex for optimal balance of response and comfort
- Fusion XR Baseplate for superior board feel and control

Terrain



Personality/Flex

Mid-stiff & lively - 4/5

Weight per pair:

1.8 kg (size M)

Features

- Fusion XR Baseplate
- ImpactCush Footbed
- AsymFlex Highback
- DualFlex Ankle Strap
- Adaptive Fit Toe Strap

- Alloy Buckles
- LSR 2.1 Auto-Lock Toe Buckle UPDATED
- Universal mounting disk
- Tool-less strap adjustment
- Tool-less forward-lean adjustment



BLACK SURF SERIES



BOREALIS BLACK/PINK



CLOUD WHITE



POLAR BLUE



STEALTH BLACK



MTN BLACK/SILVER

Nebula FASE®

NEW MODEL

UNISEX

The next-gen playful all-mountain binding

Versatile, comfortable, fast entry

Ideal for all-terrain cruising, tweaking, and surf slashing



CLOUD WHITE



STEALTH BLACK

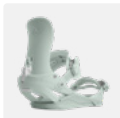

ICY BLUE

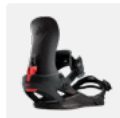

TWEAKER BLACK/RED

The Nebula FASE® is a next-gen playful all-mountain binding built for comfort and style. Its tweak-friendly flex and plush underfoot cushioning deliver versatile performance and great board feel, while the FASE® Fast Entry System offers rapid entry and exit with the trusted feel of a two strap system. The Nebula FASE® allows you to unlock creativity and elevate your style anywhere on the mountain.

Terrain



Personality/Flex

Friendly & playful - 2/5

Weight per pair:

1.9 kg (size M)

- FASE® Fast Entry System for rapid, effortless entry and exit
- Mid-soft flex for all-day comfort and creative riding
- D-Fuse XR Baseplate for natural board feel and underfoot cushioning

Features

- D-Fuse XR Baseplate NEW
- ImpactPulse Footbed NEW
- AsymFlite Highback NEW
- SensiFlex Ankle Strap NEW
- Adaptive Fit Toe Strap
- Alloy Buckles
- LSR 2.1 Auto-Lock Toe Buckle UPDATED
- Universal mounting disk
- Tool-less strap adjustment
- Tool-less forward-lean adjustment



FEEL THE POWER IN EVERY TURN

Traditional Two-Strap Bindings

Freeride mode VS Surf mode

Jones bindings offer customizable dampening and response by switching between Surf Mode and Freeride Mode. Surf Mode lets you tweak harder, while Freeride Mode keeps you locked in for maximum response. Switch modes by changing the bushings from soft (Surf Mode) to hard (Freeride Mode) and adjusting the Flip-It ankle straps. The Flip-It strap allows you to

interchange the ankle straps between the left and right binding to create custom response. Ride with the ankle straps in Freeride mode for more lateral support and board response or flip the straps into Surf Mode for solid heel support, but more ankle flexibility for getting loose.



Freeride mode

- Position the wide half of the strap above the buckle for more lateral support and board response
- Use Hard Bushings for maximum response

Surf mode

- Position the wide half of the strap below the buckle for solid heel support but more ankle flexibility for getting loose
- Use Soft Bushings for a looser, more dynamic surf feel



4x4, 2x4, est/channel disk

All Jones bindings include a mounting disk compatible with traditional 4x4 inserts, 2x4, and EST/Channel mounting system.



ZyTech buckles

Ultra-strong levers made out of Zytel Fiber Composite material with strong stainless steel springs and axis. Triple action ratchet increase speed of entry.

Size chart

MEN	S	M	L	WOMEN	S	M	YOUTH	XXS	XS	S
US	5 - 7	7.5 - 10	10.5 +	US	5 - 8.5	9 - 11.5	US	7C - 12C	12C - 4	4 - 7
EU	36.5 - 39.5	40 - 43	43.5 +	EU	35 - 39.5	40 - 42.5	EU	24 - 30.5	30 - 35.5	35 - 39.5
MD	23.5 - 25	25.5 - 28	28.5 +	MD	22 - 25	25.5 - 27.5	MD	13 - 18	18-23	22.5 - 26



Durability

Designed for durability. Lifetime warranty on binding Hanger and Post. 1 year warranty on all other binding components.

SKATE TECH
Men's Apollo Pro

The premium freeride binding

Powerful, responsive, made for charging
 Ideal for high powered freeriding and high speed carving

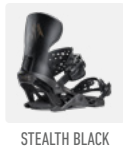
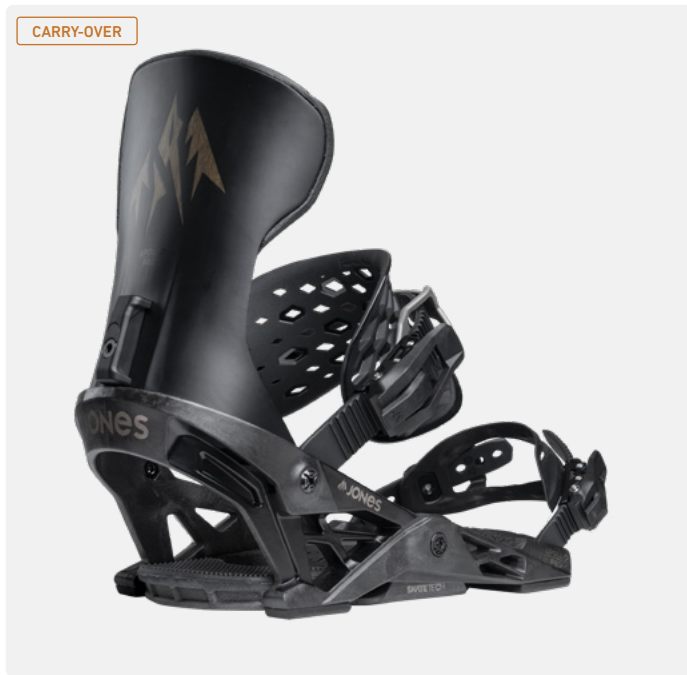

The Apollo binding is designed for expert freeriders who need unmatched edge control, response and comfort for riding fast and carving hard.

- Stiff flex for max response
- Carbon injected Hanger 3.0 for ultralight response
- Flax / Carbon highback for max support

Terrain



Personality/Flex

Stiff & Powerful - 5/5

Flip-It ankle strap technology

Side 1: Freeride mode
 Side 2: Surf mode

Included bushings:

Hard - Freeride mode

Weight per pair:

1.55 kg (size M)

Features

- | | |
|-------------------------------|----------------------------------|
| Carbon injected Hanger 3.0 | 3D Flex Fit 2.5 toe straps |
| Nylon, recycled carbon post | ZyTech buckles |
| Flushcup technology | Tool-less strap adjustment |
| Universal mounting disk | Hinge connector strap attachment |
| Response Tri-Foam foot pillow | Pre-curved ladders |
| Flax/Carbon highback | Power Spine ankle straps |

SKATE TECH
Men's Mercury

The powerful, versatile freeride binding

Nimble power, responsive, comfortable
 Ideal for creative freeriding and all-terrain freestyle

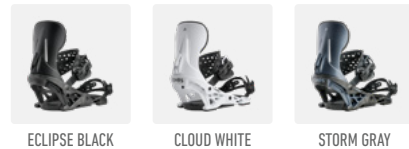

The Mercury is designed for expert freestylin' freeriders who need a supremely comfortable and responsive binding with a maneuverable medium stiff flex.

- Mid-Stiff flex for precise response
- Skate Tech for ultimate energy transfer
- Control Flex highback for solid support

Terrain



Personality/Flex

Mid-stiff & lively - 4/5

Flip-It ankle strap technology

Side 1: Freeride mode
 Side 2: Surf mode

Included bushings:

Hard - Freeride mode

Weight per pair:

1.65 kg (size M)

Features

- | | |
|----------------------------|----------------------------------|
| Carbon injected Hanger 3.0 | Power Spine ankle straps |
| Nylon post | 3D Flex Fit 2.5 toe straps |
| Flushcup technology | ZyTech buckles |
| Universal mounting disk | Tool-less strap adjustment |
| 3° canted foot pillow | Hinge connector strap attachment |
| Control Flex highback | Pre-curved ladders |

SKATE TECH
Men's Orion

The playful, precise freeride binding

Versatile, comfortable, carve or tweak
Ideal for summit to park freestyle and playful freeriding



The Orion binding is designed for fun focused freeriders who are looking for a comfortable freeride binding with a freestyle medium soft flex.

- Medium flex for playful, precise control
- Skate Tech for ultimate energy transfer
- Progressive flex highback for plush support

Terrain



Personality/Flex

Happy medium - 3/5

Flip-It ankle strap technology

Side 1: Freeride mode
Side 2: Surf mode

Included bushings:

Soft - Surf mode

Weight per pair:

1.64 kg (size M)

Features

- Nylon post
- Flushcup technology
- Universal mounting disk
- Comfort foam foot pillow
- Hanger 3.0
- Progressive Flex highback

- Comfort Flex ankle straps
- 3D Flex Fit 2.5 toe straps
- ZyTech buckles
- Tool-less strap adjustment
- Hinge connector strap attachment
- Pre-curved ladders

SKATE TECH
Men's Meteorite

The friendly all-mountain binding

Playful, comfortable, freestyle friendly
Ideal for all-terrain cruising, freestyle and surf slashing

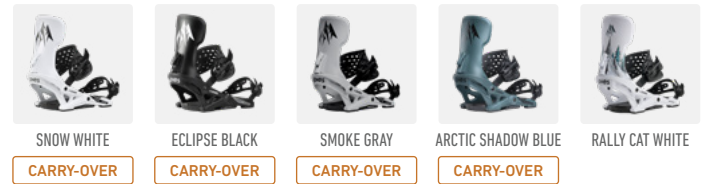

The Meteorite binding is designed for the all-mountain rider that wants a stable and comfortable binding with a tweak-able medium soft flex.

- Mid-Soft flex for friendly maneuverability
- Skate Tech for ultimate energy transfer
- Dynamic Flex highback for tweak-able control

Terrain



Personality/Flex

Friendly & playful - 2/5

Flip-It ankle strap technology

Side 1: Freeride mode
Side 2: Surf mode

Included bushings:

Soft - Surf mode

Weight per pair:

1.68 kg (size M)

Features

- Nylon post
- Flushcup technology
- Universal mounting disk
- 3° canted foot pillow
- Hanger 2.0
- Dynamic Flex highback

- Power ankle straps
- 3D Flex Fit 2.5 toe straps
- ZyTech buckles
- Tool-less strap adjustment
- Hinge connector strap attachment
- Pre-curved ladders

SKATE TECH
Women's Aurora

The playful, precise freeride binding

Versatile, comfortable, carve or tweak
 Ideal for summit to park freestyle and playful freeriding

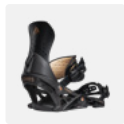

ECLIPSE BLACK

CARRY-OVER

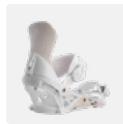

MISTY WHITE

The Women's Aurora binding is designed for fun focused freeriders who are looking for a comfortable freeride binding with a freestyle medium soft flex.

- Medium flex for playful, precise control
- Skate Tech for ultimate energy transfer
- Progressive flex highback for plush support

Terrain



Personality/Flex

Happy medium - 3/5

Flip-It ankle strap technology

Side 1: Freeride mode
 Side 2: Surf mode

Included bushings:

Soft - Surf mode

Weight per pair:

1.55 kg (size M)

Features

- Nylon post
- Flushcup technology
- Universal mounting disk
- Comfort foam foot pillow
- Hanger 3.0
- Progressive Flex highback

- Comfort Flex ankle straps
- 3D Flex Fit 2.5 toe straps
- ZyTech buckles
- Tool-less strap adjustment
- Hinge connector strap attachment
- Pre-curved ladders

SKATE TECH
Women's Equinox

The friendly all-mountain binding

Playful, comfortable, freestyle friendly
 Ideal for all-terrain cruising, freestyle and surf slashing

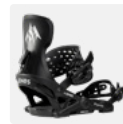

ECLIPSE BLACK

CARRY-OVER



CLOUD WHITE

CARRY-OVER



FROZEN PINK



FROZEN BLUE

The Women's Equinox binding is designed for the all-mountain rider who wants a stable and comfortable binding with a tweak-able medium soft flex.

- Mid-Soft flex for friendly maneuverability
- Skate Tech for ultimate energy transfer
- Dynamic Flex highback for tweak-able control

Terrain



Personality/Flex

Friendly & playful - 2/5

Flip-It ankle strap technology

Side 1: Freeride mode
 Side 2: Surf mode

Included bushings:

Soft - Surf mode

Weight per pair:

1.56 kg (size M)

Features

- Nylon post
- Flushcup technology
- Universal mounting disk
- 3° canted foot pillow
- Hanger 2.0
- Dynamic Flex highback

- Power ankle straps
- 3D Flex Fit 2.5 toe straps
- ZyTech buckles
- Tool-less strap adjustment
- Hinge connector strap attachment
- Pre-curved ladders

Youth Asteroid

The next level youth binding

Playful, comfortable, freestyle friendly

Ideal for all-terrain ripping, freestyle and pow slashing

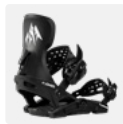
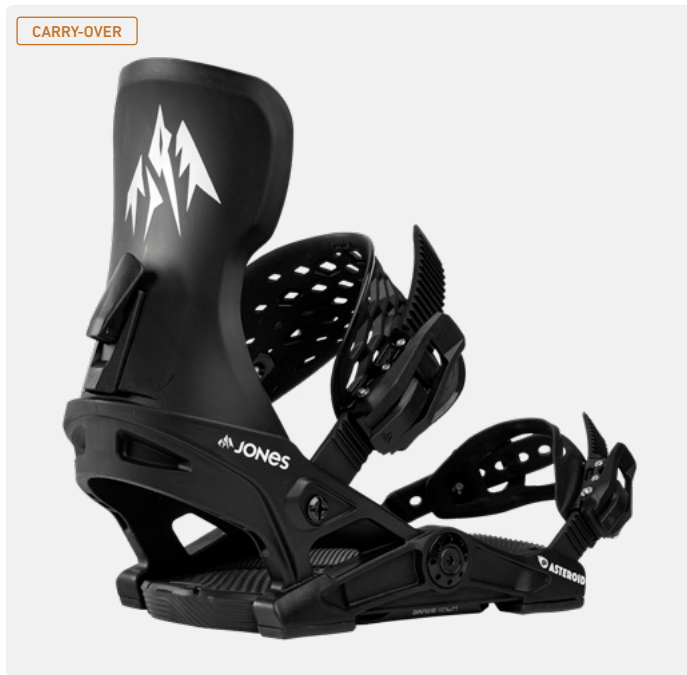

ECLIPSE BLACK

Kids Eclipse

The adjustable size kids binding

Adjustable, comfortable, all-mountain friendly

Ideal for fast growing young rippers

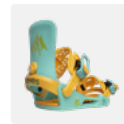
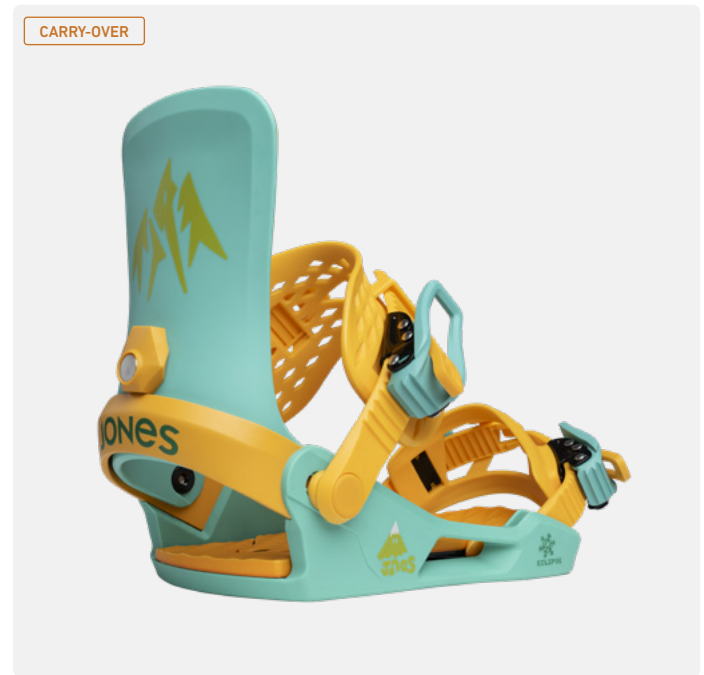

ARCTIC SUNSHINE BLUE

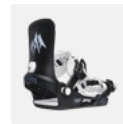

BLIZZARD BLACK

The Asteroid binding is designed for the hard charging youth rider who wants a stable and comfortable binding with a tweak-able medium soft flex.

- Mid-Soft flex for friendly maneuverability
- Skate Tech for ultimate energy transfer
- Dynamic Flex highback for tweak-able control

Terrain



Personality/Flex

Happy medium - 3/5

Flip-It ankle strap technology

Side 1: Freeride mode
Side 2: Surf mode

Included bushings:

Soft - Surf mode

Weight per pair:

1.48 kg (size S)

Features

- Nylon post
- Flushcup technology
- Universal mounting disk
- Comfort foam foot pillow
- Hanger 1.0
- Dynamic Flex highback

- Power ankle straps
- 3D Flex Fit 2.5 toe straps
- ZyTech buckles
- Tool-less strap adjustment
- Hinge connector strap attachment
- Pre-curved ladders

The Eclipse binding is a high performance kids binding with an adjustable heel cup that allows you to make the binding bigger as your grom changes boot sizes.

- Soft flex for easy maneuverability
- Adjustable length heel cup for universal fit
- Durable asymmetric highback for turn support
- Durable and secure injection molded straps
- Durable and easy-to-ratchet aluminum buckles
- Universal Compatibility: 4x4, 4x2 & Channel

Features

Featuring a toolless adjustable length heel cup that allows you to make the binding bigger.

Mounted with comfortable, durable and secure injected molded straps.

Asymmetric nylon highback with EVA foam pad for responsive support and comfort.

Durable and easy-to-ratchet aluminum buckles to keep your boots locked in.

Weight per pair:

1.45 kg (size S)
1.27 kg (size XS)

Kids Happy Mountain

The learn-to-ride kids binding

Easy-to-strap, comfortable, secure
Ideal for learning to glide and slide



ICY HORIZON BLUE

The Happy Mountain is an adjustable size, one-strap kids binding made for young first time rippers who are learning to glide and slide down the mountain.

- Soft flex for easy maneuverability
- Lightweight yet tough polycarbonate baseplate
- One-strap, one-buckle design for ease of use
- Toolless adjustable size highback for support
- Oversized buckle for easy strapping
- Integrated 4x4 and 4x2 mounting system

Features

Featuring a one-strap, one-buckle design that makes strapping in quick and easy.

Lightweight yet durable polycarbonate baseplate with integrated mounting system.

Soft flexing and size adjustable nylon highback offers playful support and universal fit.

Compatible with most kids boards with 4x4 and 4x2 binding inserts.

Weight per pair:

0.74 kg (size XXS)





INSTRUMENTS OF STOKE

Snowboards & Splitboards

Our mission is to design the ultimate snowboards and splitboards
with industry leading responsible manufacturing practices.

Visual Line Plan

PRICE ↑



Men's Howler



NEW SIZES

Women's Howler



NEW SIZES

Men's Stratos



CARRY OVER

Women's Stratos



CARRY OVER

Men's Frontier 2.0



Women's Dream Weaver 2.0



Men's Flagship Pro



NEW SIZES

CARRY OVER

Men's Ultralight Project X



NEW SIZES

Men's Flagship



Women's Flagship



Hovercraft 2.0



CARRY OVER

TwinCraft



NEW MODEL

Mind Expander 2.0



NEW SHAPE

Storm Wolf



Mountain Surfer



Storm Chaser



2026-2027 Model Matrix

ALL-MOUNTAIN FREERIDE

Directional shapes that maximize float, speed and response for supreme freeride performance and all-mountain versatility.



Men's Ultralight Project X

Flyweight all-mountain razor

Directional/Dir. Camber-Rocker

Flex: 3/5

156 · 159 · **161W**

CARRY OVER

NEW SIZE



Men's Flagship Pro

Only for the expert freerider

Directional/Dir. Camber-Rocker

Flex: 5/5

154 · 158 · 159W · 161 · 162W

164 · 165W



Men's Flagship

The freeride foundation

Directional/Dir. Camber-Rocker

Flex: 4/5

151 · 154 · 156W · 158 · 159W · 161

162W · 164 · 165W · 167 · 169W · 172



Men's Howler

The creative freerider's favorite

Directional/High Power Camber

Flex: 4/5

152 · 155 · 157W · 158 · 160W

161 · 163W · **164**

NEW SIZE



Men's Stratos

The versatile all-terrain freerider

Directional/Dir. Camber-Rocker

Flex: 3/5

149 · 153 · 154W · 156 · 158W

159 · 161W · 162 · 164W

CARRY OVER



Men's Frontier 2.0

The all-terrain, shred anything board

Directional/Dir. Camber-Rocker

Flex: 2/5

150 · 153 · 155W · 156 · 158W · 159

161W · 162 · 164W · 165 · 167W



Hovercraft 2.0

The evolved all-conditions charger

Directional/Dir. Camber-Rocker

Flex: 3/5

144 · 148 · 152 · 156 · 160 · 164

CARRY OVER

UNISEX

ALL-MOUNTAIN

Directional Twin shapes built for maximum versatility on any terrain and in all conditions, made to ride every day of the season.

WOMEN'S



Men's Aviator 2.0

The precision tool for all-terrain performance

Directional Twin/True High-Camber

Flex: 4/5

147 · 150 · 153W · 154 · 156 · 157W

158 · 159W · 160 · 162 · 163W

CARRY OVER



Men's Mountain Twin Pro

The ultimate all-mountain powerhouse

Directional Twin/CamRock

Flex: 4/5

154 · 156W · 157 · 159W · 160

162W · 163 · 165W



Men's Mountain Twin

The definitive do-it-all board

Directional Twin/CamRock

Flex: 3/5

149 · 151 · 153W · 154 · 156W · 157

158UW · 159W · 160 · **161UW** · 162W

163 · **164UW** · 165W · 168W

NEW SIZES



Men's Rally Cat

The all-mountain fun seeker

Directional Twin/True Medium-Camber

Flex: 2/5

151 · 154 · 155W · 156 · 158 · 159W

161 · 162W · 166W · 170W



Women's Airheart 2.0

The precision tool for all-terrain performance

Directional Twin/True High-Camber

Flex: 4/5

143 · 146 · 149 · 152 · 155

CARRY OVER



Women's Twin Sister

The definitive do-it-all board

Directional Twin/CamRock

Flex: 3/5

140 · 143 · 146 · 149 · 152 · 155



Women's Rally Cat

The all-mountain fun seeker

Dir. Twin/True Medium-Camber

Flex: 2/5

139 · 142 · 145 · 148 · 151 · 154

WOMEN'S



Women's Flagship

The ultimate freeride board
Directional/Dir. Camber-Rocker
Flex: 4/5
143 · 146 · 149 · 152 · 155

NEW SIZE



Women's Howler

The creative freerider's favorite
Directional/High Power Camber
Flex: 4/5
142 · 145 · 148 · 151

NEW SIZE



Women's Stratos

The versatile all-terrain freerider
Directional/Dir. Camber-Rocker
Flex: 3/5
140 · 143 · 146 · 149 · 152 · 155

CARRY OVER



Women's Dream Weaver 2.0

The playful charger
Directional/Dir. Camber-Rocker
Flex: 2/5
139 · 142 · 145 · 148 · 151 · 154 · 156

ALL-MOUNTAIN FREESTYLE

True Twin shapes built for popping, pressing, spinning, slashing and creative riding across the whole mountain.

WOMEN'S



Men's Tweaker Pro 2.0

The supercharged freestyler, reimagined
True Twin/True High-Camber
Flex: 4/5
149 · 151 · 154 · 156 · 157W · 159

NEW SHAPE



Men's Tweaker 2.0

The updated fun hoggini' freestyler
True Twin/True Medium-Camber
Flex: 2/5
149 · 151 · 154 · 156 · 157W
159 · 160W · 162

NEW SHAPE



Women's Tweaker 2.0

The updated fun hoggini' freestyler
True Twin/True Medium-Camber
Flex: 2/5
140 · 143 · 146 · 149 · 151

NEW SHAPE



Freecarver 6000s

The playful all-mountain carver
Directional/True Medium-Camber
Flex: 3/5
150 · 150N · 154 · 154N · 158
158N · 162



Freecarver 9000s

The powerful all-mountain carver
Directional/True Medium-Camber
Flex: 4/5
152 · 152N · 156 · 156N · 160 · 164

FREECARVER SERIES UNISEX

High powered true camber all-mountain carving boards designed to help you carve the best turns of your life.

2026-2027 Model Matrix

SURF SERIES UNISEX

Surf-inspired boards for effortless turns and glide in any terrain, shaped by Chris Christenson



TwinCraft

The floaty fun freestyler

Directional Twin/True Medium-Camber

Flex: 3/5

146 · 150 · 154 · 158 · 162

NEW MODEL



Mind Expander 2.0

Alternative all-mountain shredder

Directional/Dir. Camber-Rocker

Flex: 3/5

142 · 146 · 150 · 154 · 158 · 162 · 166

NEW SHAPE

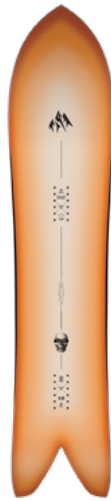

Storm Chaser

Surf inspired powder slasher

Directional/Dir. Camber-Rocker

Flex: 3/5

142 · 147 · 152 · 157



Storm Wolf

The slicing and dicing speed arrow

Directional/Dir. Camber-Rocker

Flex: 4/5

150 · 154 · 158 · 162



Mountain Surfer

Next level surf sled

Directional/Christenson Surf Rocker

Flex: 3/5

142 · 152

SPLITBOARDS

Backcountry splitboards engineered for efficient climbs and dynamic descents, built to take you deeper, further, higher into every mountain range.



UltraLight Butterfly Split

The ultralight, technical objective split

Directional/True High-Camber

Flex: 4/5

150 · 154 · 158

CARRY OVER

UNISEX



UltraLight Hovercraft 2.0 Split

The ultralight, all-conditions split

Directional/Dir. Camber-Rocker

Flex: 4/5

152 · 156 · 160

CARRY OVER

UNISEX



Men's UltraLight Solution Split

The backcountry line bomber

Directional/Dir. Camber-Rocker

Flex: 5/5

158 · 161 · 162W · 164 · 165W

CARRY OVER



Men's Solution Split

The ultimate, all-conditions split

Directional/Dir. Camber-Rocker

Flex: 4/5

154 · 158 · 159W · 161 · 162W · 164

165W · 167 · 169W

CARRY OVER



Men's Howler Split

The freeride x freestyle full-throttle split

Directional/High Power Camber

Flex: 4/5

158 · 160W · 161

NEW MODEL



Men's Stratos Split

The energetic, all-conditions split

Directional/Dir. Camber-Rocker

Flex: 3/5

156 · 158W · 159 · 161W

CARRY OVER



Men's Frontier 2.0 Split

The all-terrain, shred everything split

Directional/Dir. Camber-Rocker

Flex: 2/5

156 · 158W · 159 · 161W · 162 · 164W

YOUTH SERIES

From first turns to freeride lines, the Youth Series covers every stage of progression with trusted Jones technologies.



Solution Junior Split

Serious backcountry tool for smaller riders

Directional/Dir. Camber-Rocker

Flex: 4/5

137 - 142 - 147



Flagship Junior

Serious shred stick for smaller riders

Directional/Dir. Camber-Rocker

Flex: 4/5

127 - 132 - 137 - 142 - 147



Mountain Twin Junior

The definitive do-it-all board

Directional Twin/CamRock

Flex: 3/5

120 - 125 - 130 - 135 - 140 - 145



Twin Sister Junior

The definitive do-it-all board

Directional Twin/CamRock

Flex: 3/5

120 - 125 - 130 - 135



Also available as package



Youth Prodigy

The first step to progression

Directional Twin/CamRock

Flex: 2/5

80 - 90 - 100 - 110 - 115 - 120 - 125

130 - 135 - 140 - 145

CARRY OVER

NEW SIZES



Also available as package



Kids Happy Mountain

First board for a young ripper

True Twin/FlatRock

Flex: 1/5

90

CARRY OVER

WOMEN'S

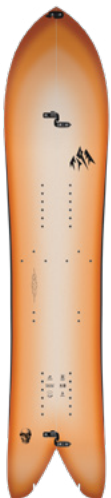

Storm Chaser Split

The backcountry surf slasher

Directional/Dir. Camber-Rocker

Flex: 3/5

152

UNISEX



Hovercraft 2.0 Split

The evolved backcountry racer

Directional/Dir. Camber-Rocker

Flex: 3/5

148 - 152 - 156 - 160

CARRY OVER

UNISEX



Women's Solution Split

The ultimate women's split

Directional/Dir. Camber-Rocker

Flex: 4/5

146 - 149 - 152 - 155

CARRY OVER



Women's Howler Split

The freeride x freestyle full-throttle split

Directional/High Power Camber

Flex: 4/5

148 - 151

NEW MODEL



Women's Stratos Split

The energetic, all-conditions split

Directional/Dir. Camber-Rocker

Flex: 3/5

146 - 149 - 152

CARRY OVER



Women's Dream Weaver 2.0 Split

The playful backcountry charger

Directional/Dir. Camber-Rocker

Flex: 2/5

145 - 148 - 151 - 154

Profiles

Directional Camber/Rocker

This profile is built around camber under your foot, giving you powerful edge hold, precise response, and confidence at speed. The nose features rocker that lifts the contact point for smooth turn initiation, effortless float in powder, and improved maneuverability in deep snow.

Cambered Tail for Control

Some models feature a fully cambered tail, with no rocker. This design maximizes drive and stability, locking the edge for powerful carves and dependable control in steep, technical terrain.

Rockered Tail for Maneuverability

Other models, a touch of rocker in the tail makes the board easier to release out of turns, adds playfulness, and enhances maneuverability. The lifted tail brings a looser, more surfy feel when slashing or pivoting in all snow conditions.

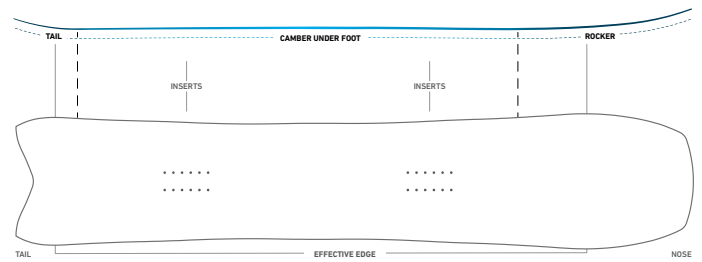

DRAWING OF THE HOVERCRAFT 2.0, SIZE 160

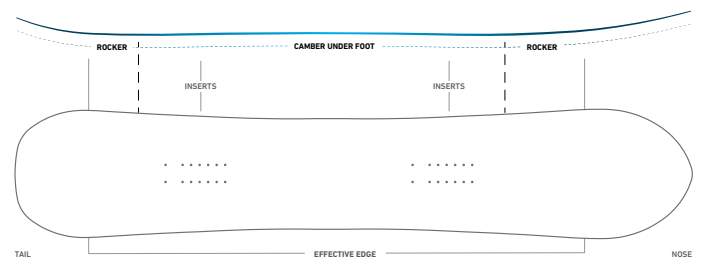

DRAWING OF THE MEN'S FRONTIER 2.0, SIZE 159

“

My experience is that most falls in freeriding start from the nose of the board – you either go over the bars in powder, the nose gets caught under a weird crust and tosses you, or you hit a hard transition at the contact point of the tip and get bucked. Directional Camber/Rocker eliminates most of these falls.



JEREMY JONES



CamRock

A unique all-terrain rocker/camber profile defined by evenly balanced tip and tail rocker with camber between the bindings. This blend delivers confident edge hold and responsive turns while keeping the tips loose enough for effortless float in powder. CamRock is our most versatile all-mountain profile, engineered to excel everywhere from piste to park to pow.

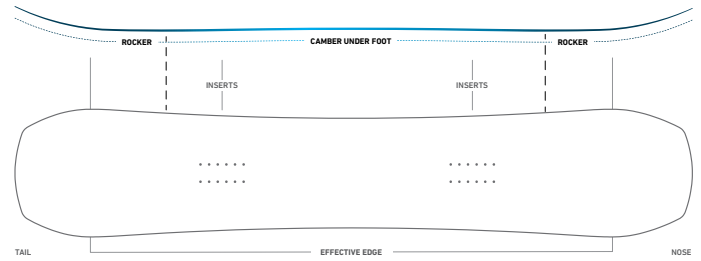

DRAWING OF THE MEN'S MOUNTAIN TWIN, SIZE 157

True Camber

A full camber profile that delivers maximum energy and edge response without the usual hang-ups. The continuous camber shape offers powerful turns, locked-in stability at speed, and unmatched pop for dynamic riding. True Camber is ideal for riders who want the highest level of control and precision, whether carving hardpack, charging steeps, or dropping lines in powder.

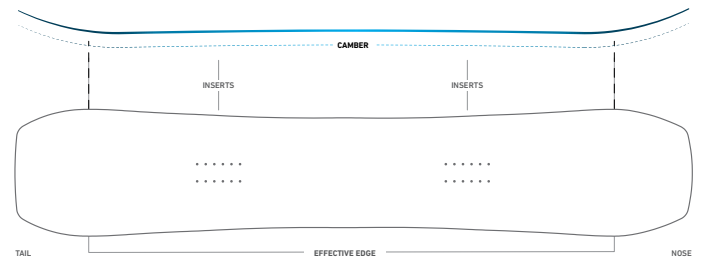

DRAWING OF THE MEN'S AVIATOR 2.0, SIZE 158

High Power Camber

Tip-to-tail full camber profile with a high camber along the effective edge for unmatched pop. The camber profile rises towards the tail and extends to the back binding for increased stomping power on the back foot.

Christenson Surf Rocker

A custom surf-inspired tip/tail rocker profile designed by surf shaper Chris Christenson. When you weight the tail of the board the nose ramps up out of the snow for insane float on the deepest days. These subtle rocker contours match a Christenson surfboard rocker profile.

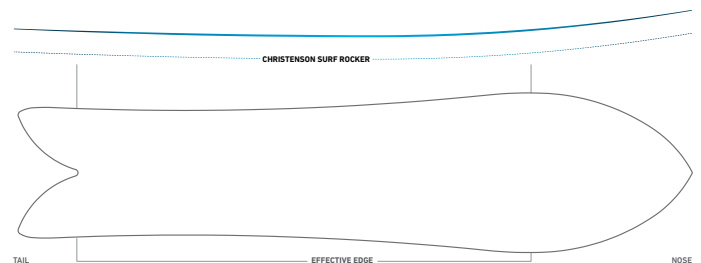

DRAWING OF THE MTN SURFER, SIZE 142

3D Contour Bases

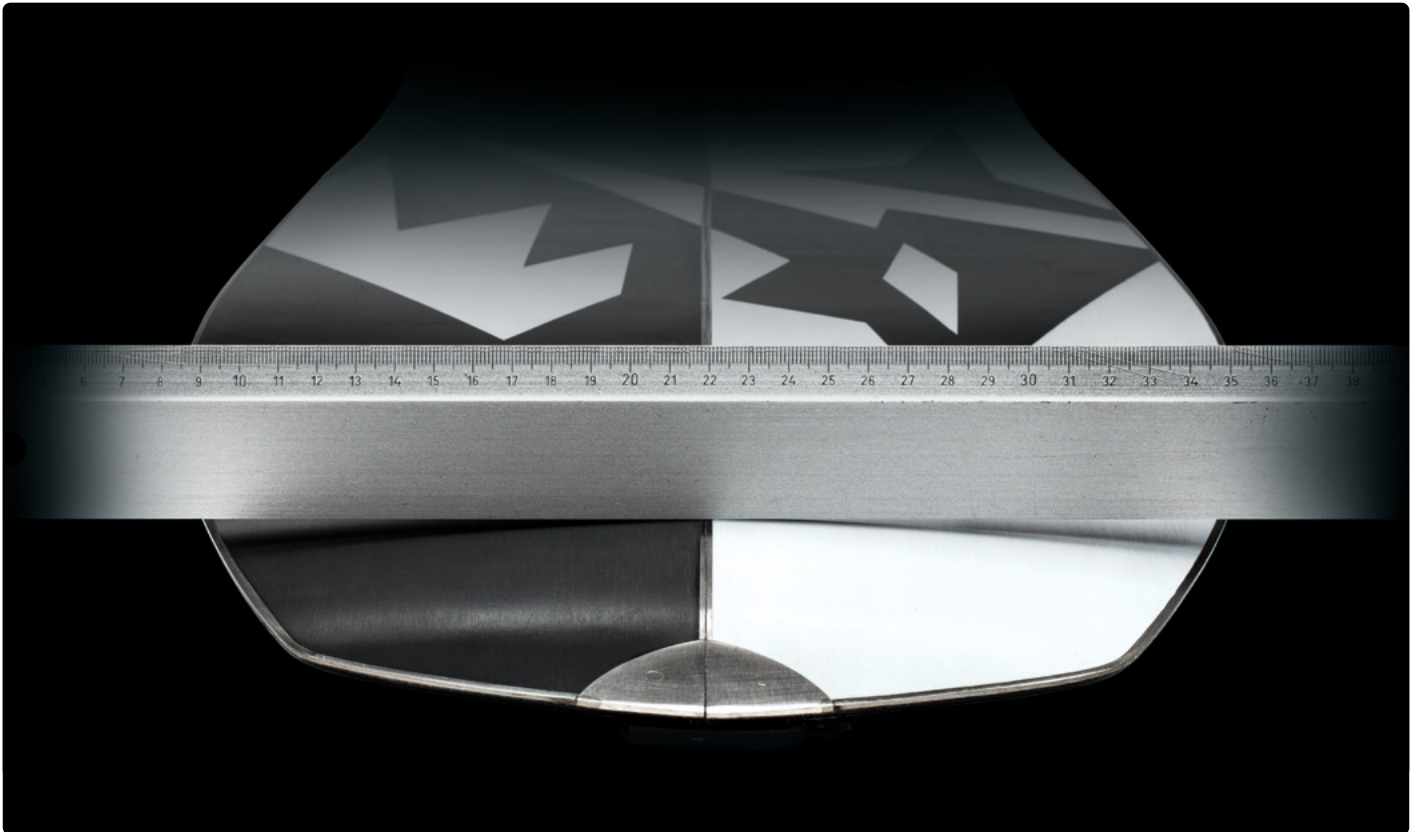

Next level technology for ultimate response

Nobody wants a choppy and rough run. The descents you dream about are dynamic and smooth. Inspired by the rounded bottom contours of surfboards, 3D Contour Bases are designed to make every run smoother and every turn more effortless by reducing the drag of the board tips. 3D Contour Bases enhance glide and improve float helping you ride faster and with better flow.

Glide

3D Contour Bases enhance glide. The smooth radius of the nose and tail edges reduce friction at the contact points. With less friction and catch in the tips, you can maintain more speed.

Flow

3D Contour Bases deliver unmatched turn flow and fluidity. Just like the nose and tail on a surfboard, the rounded tip and tail edges eliminate catch as you transfer pressure edge-to-edge. Turn initiation is effortless because you can roll the board on to the edge instead of tip the board on the edge. Once on edge, camber and Traction Tech lock in your turn.

Float

3D Contour Bases generate float. The subtle shaping in the nose and tail of the board helps to displace snow out from the base and lift the board's nose above the surface of the snow.



On a surfboard, the subtle shaping of the nose is what makes the entry into a turn so smooth and fluid. The feeling of an effortless surf turn is what inspired the development of our 3D Contour Bases. Instead of having to abruptly tip the board into a turn, 3D Contour Bases let you roll your edge into a turn. I've been on a quest to design a snowboard that offers the free friction glide and edge-to-edge fluidity of a surfboard for years. 3D Contour Bases cracked the code on how to achieve this next level of board performance.



JEREMY JONES

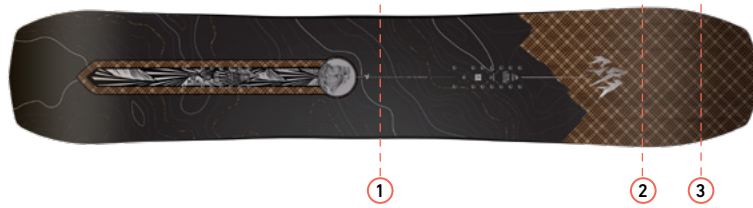

1 Center

The center of the board is perfectly flat with no spoon bevel on the edges between the contact points. The flat base allows instantaneous edge engagement between the feet when you lean into a turn.

2 Contact points

The spoon bevel starts just before contact point. The bevel increases very gradually so there is not an abrupt transition between the flat center of the board and the raised tip and tail edges.

3 Nose and tail edges

The spoon bevel is most defined at the tip and tail of the board. The rounded edges at the tips reduce edge catch and drag.



Riding flat

When riding flat, the spoon bevel on the edges is not engaged, but it does help smoothly deflect snow away from the nose of the board.



Turn initiation

As you begin to make a turn the spoon bevel helps you smoothly roll the board on to your edge with less friction and edge drag.



Mid-turn

In the middle of a turn camber and traction tech keep you locked onto your edge in the center of the board while the spoon bevel reduces the "plow effect" of your nose and tail edges.

The unique riding personality of each board in our collection demanded we develop multiple 3D Contour Base designs. Not every model would benefit from the same amount of spoon bevel. Each 3D Contour Base design is matched to the attitude of the board.

High 3D Contour Base

Freeride focused 3D Contour Base featuring 7mm of spoon bevel in the nose and 0 to 7mm of spoon bevel in the tail. Spoon bevel starts just before contact point.

Medium 3D Contour Base

3D Contour Base tuned for all-terrain featuring 4mm spoon bevel in the nose and 0 to 4mm spoon bevel in the tail. Spoon bevel starts just before contact point.

Low 3D Contour Base

Subtle yet effective 3D Contour Base featuring 2mm spoon bevel in the nose and 0 to 2mm spoon bevel in the tail. Spoon bevel starts just before contact point.

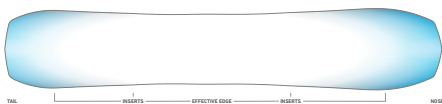

DRAWING OF THE MEN'S FLAGSHIP, SIZE 161



DRAWING OF THE MEN'S AVIATOR 2.0, SIZE 158



DRAWING OF THE MEN'S RALLY CAT, SIZE 154

Innovative construction technologies

Jones PRO and Ultralight constructions showcase our meticulous craftsmanship and set industry leading performance standards

[PRO] Construction NEW

Our highest performance snowboards built for expert riders.

The PRO Construction combines our most advanced materials to deliver maximum power, precision, and durability. From basalt laminates to Koroyd inserts, every ingredient is selected to push board performance to its limit and deliver a competition-ready ride in all conditions.

- Full basalt laminate for torsional response, stability, and damping
- Fastest sintered base for superior glide
- Koroyd inserts to absorb vibration and reduce swing weight
- Reinforced edges for maximum durability
- Precision-engineered woodcores for the most technical flex and strength

[Ultralight Carbon] Construction

Ultra-responsive and weight-optimized for big mountain touring.

The Ultralight Carbon Construction is built for splitboarders taking on long tours, big vertical, and technical objectives where every saved gram means more energy for the ride. It delivers a ride that is powerful, stable and confidence-inspiring when it's time to drop in.

The construction starts with Fusion Carbon, combining carbon fiber and fiberglass for a board feel that is super responsive, stable and damp. Every element, from Koroyd inserts to our lightest Fusion Core, is engineered to maximize touring performance while maintaining durability and control in demanding terrain.

- Fusion Carbon construction with carbon fiber and fiberglass for ultralight response and stability
- Koroyd inserts absorb vibration, reduce swing weight and lower overall weight
- Fusion Core is our lightest and dampest woodcore with the best strength to weight ratio
- Bombproof thinner edges reduce weight without compromising durability
- Ultralight eco topsheets are durable and scratch resistant
- Ultra Base is our fastest sintered base for unmatched glide
- Karakoram Ultra Clips 3C provide the most secure and reliable splitboard connection



Ingredients

Built with the finest tech and materials.

100% of our adult models feature high-end materials, construction technologies and responsible manufacturing processes. We accept no compromises in producing the most durable and responsibly produced snowboarding gear.

- 100% Fair Trade Certified
- 100% Progressive Sidecut
- 100% Sintered Base
- 100% Recycled Abs Sidewall
- 100% Bio Resin
- 100% Wend Bio Wax
- 100% 3D Contours Base
- 100% Solar Built
- 100% Inner Edge Traction Tech
- 100% Responsible Woodcores

BASES

Sintered bases

All Jones adult models feature sintered bases. Our bases are made out of Ultra-High Molecular Weight polyethylene and are super durable and wax absorbent.

Sintered 8000 Base

Premium sintered base material that's ultra fast, highly wax absorbent, easy to repair and proven to be one of the most durable and long lasting base materials in the industry.

Sintered 9900 Base

High performance sintered base material with carbon additives that offers unrivaled speed, durability and wax absorption. Made in Austria.

Extruded 5000 Base

Premium extruded base material that is fast, durable, easy to repair, and offers consistent performance with minimal maintenance.

Ultra Base

Jones exclusive sintered base material with carbon additives for industry leading speed and wax absorption. Infused with multiple wax types for supreme glide in warm, wet and variable snow. Made in Austria.

Recycled Sintered 9900 Base

High performance sintered base material made from 50% virgin material and 50% recycled factory scraps that offers unrivaled speed, durability and wax absorption. Made in Austria.

Flip-Flop Base

Jones models with Flip-Flop bases are made in two base colorways to minimize P-Tex waste. Orders may be filled with either color and color does not vary by size.

TOPSHEET

Responsibly sourced topsheets

All adult Jones topsheets are made with materials that are responsibly sourced. Some of our models feature ECO-plastic topsheets and several feature wood veneer topsheets.

Premium Topsheet

Durable and scratch resistant premium topsheet engineered to endure rigorous daily use in extreme conditions.

Premium Eco Topsheet

Durable and scratch resistant bio-plastic topsheet made from castor beans that's engineered to provide exceptional abrasion and impact resistance while minimizing environmental impact.

Ultralight Eco Topsheet

Ultralight version of our castor bean sourced, bio-plastic topsheet that's engineered to be extremely durable and scratch resistant while minimizing environmental impact.

Flax Fiber

Carbon neutral flax fiber topsheet layer that's abrasion resistant and absorbs chatter in rough snow.

Ash Wood Veneer

Lightweight and super damp Ash wood veneer topsheet layer that eliminates edge chatter and delivers even flex and supreme torsional stiffness.

WOODCORES

100% responsibly sourced woodcores

All Jones woodcores are made with responsibly sourced wood. Every piece of wood we use in every board comes from a responsibly managed forest.

Koroyd®

Developed from aerospace technology, award-winning Koroyd synthetic core material is the lightest core dampening material we've ever tested. It absorbs vibrations and reduces tip swing weight, enabling quicker, smoother turns, and is added directly into the woodcore.

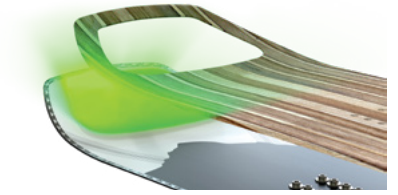

Master Core

Dual density wood core made out of responsibly harvested Paulownia and Poplar. 1:1 Paulownia to Poplar stringer ratio creates a lightweight core that's poppy and durable.

Power Core

Advanced triple-density full wood core made from responsibly harvested Bamboo, Paulownia and Poplar. Centered Bamboo stringers enhance durability, pop and torsional stiffness, while the Paulownia keeps the core light and damp.

Re-Up Tech Core

Groundbreaking wood core made out of responsibly harvested Paulownia and Poplar with specially positioned embedded stringers made from reclaimed snowboards.

Control Core

Premium dual density wood core made out of responsibly harvested Paulownia and Poplar. 2:1 Paulownia to Poplar stringer ratio creates a lightweight core that's damp and durable.

Boost Core

Advanced triple-density full wood core made from responsibly harvested Bamboo, Paulownia and Poplar. Bamboo stringers along the sidecut enhance durability, edge response and torsional stiffness, while the Paulownia keeps the core light and damp.

Ultra Split Core

Ultralight dual density wood core made primarily out of responsibly harvested Paulownia with pockets of Poplar that offers standard setting durability, pop and response.

Ultra Core

Ultralight dual density wood core made primarily out of responsibly harvested Paulownia with pockets of Poplar that offers standard setting durability, pop and response.

Fusion Core

High tech wood core crafted from select Paulownia with pockets of Poplar along the sidecut for added edge durability. Designed for Jones Ultralight models, it's our lightest core ever and offers a perfect strength-to-weight ratio.

Control Split Core

Premium dual density wood core made out of responsibly harvested Paulownia and Poplar. 2:1 Paulownia to Poplar stringer ratio creates a lightweight core that's damp and durable.

EDGES

Recycled edges

Since 2010, every Jones board has been made with partially recycled edges.

Recycled edges

Bombproof steel edges made from recycled German steel, engineered for maximum strength and long-lasting durability.

Inner thin recycled edges

Built to the same high standards as our recycled edges, but thinner and used only on the internal edges of splitboards for reduced weight.

SIDEWALLS

Recycled sidewalls

Every Jones board ever made was built with 100% recycled sidewalls.

Recycled ABS

Recycled ABS sidewalls with a rounded finish that are engineered to enhance durability by reducing topsheet chipping and impact damage.

OTHERS

Insert packs

Float Pack

Extra set of inserts allows super setback stance for deep pow days.

Freeride/Freestyle Pack

Allows option to center or set back stance on sidecut as conditions demand.

Carve Pack

Extra set of inserts allows more centered stance option for riding firm snow.

FIBERS

Premium laminates

For an even flex and unmatched durability and response, Jones boards are constructed with high quality fibers including Biax and Triax fiberglass, responsibly sourced flax and premium carbon.

Biax Fiberglass

Biaxial fiberglass laminate made with a dual-layer, dual-directional construction that delivers a forgiving yet snappy board feel with a mid-soft torsional flex and quick energy transfer.

Triax Fiberglass

Triaxial fiberglass laminate made with a triple-layer, multi-axis construction that delivers a precise and powerful board feel with a mid-stiff torsional flex for supreme response in variable snow conditions.

Basalt Fibers

Harnessing the power of nature, our PRO construction uses basalt fibers derived from volcanic rock. We layup $\pm 45^\circ$ basalt laminates for powerful energy transfer, exceptional durability, and dynamic flex across all PRO series boards.

Fusion Carbon

Ultralight Jones exclusive tip-to-tail carbon fiber and fiberglass construction that's engineered to reduce weight without sacrificing performance and response.

Stringer technologies

For unmatched vibration dampening in rough snow and lightning fast energy transfer initiating turns, we use only finely crafted stringer materials made with naturally sourced flax and responsibly sourced carbon fiber.

Bcomp Carbon Flax Stringer

Bcomp Carbon / Flax stringers offer the perfect performance balance as the carbon provides crazy pop and the flax sucks up chatter and reduces CO₂ emissions compared to a full carbon stringer. Developed in collaboration with the Swiss engineering firm Bcomp.

RESIN

Epoxy Matrix

100% of Jones boards feature Durabond Bio-Epoxy [27] for maximum durability.

Durabond Bio-Epoxy [27]

A bio-based epoxy made with 27% plant-based carbon that reduces CO₂ emissions by 33% compared to conventional petroleum-based epoxy. Sourced from plant-based industrial by-products, its unmatched bonding properties deliver industry leading durability and performance.

TUNED TO GO

100% ready to shred

Jones boards are de-tuned, waxed and ready to ride straight out of the wrapper.

Forever Flex

Forever Flex stabilizes a snowboard's flex and rocker profile for its lifetime. Boards are overbuilt, then 'broken in' using a process that mimics 20 days of riding and makes the flex more consistent from day one.

WEND Natural Wax

All Jones snowboards come factory waxed with WEND natural wax so they're ready to shred straight out of the shop.

Factory Tuned

All Jones snowboards come factory de-tuned at the tip and tail so they're ready to shred straight out of the shop.

CLIPS

100% Karakoram Split Clips

All Jones splitboards feature premium Karakoram Clips that deliver unmatched compression and board lock.

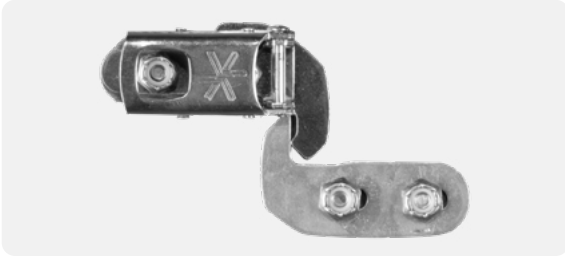

Karakoram Ultra Clips 1.0

Karakoram Ultra Clips 1.0 remain some of the strongest and lowest profile clips in the industry. They are adjustable so you can maintain even compression as your splitboard ages.



Karakoram Ultra Clips 2.0

Karakoram Ultra Clips 2.0 are lighter weight, clamp tighter and have a smaller footprint than the original Ultra clip. They are adjustable so you can maintain even compression as your splitboard ages.



Karakoram Ultra Clips 3C

Karakoram Ultra Clips 3C feature an ultralight and durable three-point tension system. They are adjustable so you can maintain even compression as your splitboard ages.



Karakoram Tip-Lock Tip Clips 2.0

New and improved Karakoram Tip-Lock Tip Clips 2.0 lock your split together with the flick of the lever and stay tightly attached to your board all season.



Karakoram Tip Clips

Karakoram Tip clips made with durable ABS that swing closed and stay tight.

Shape Tech

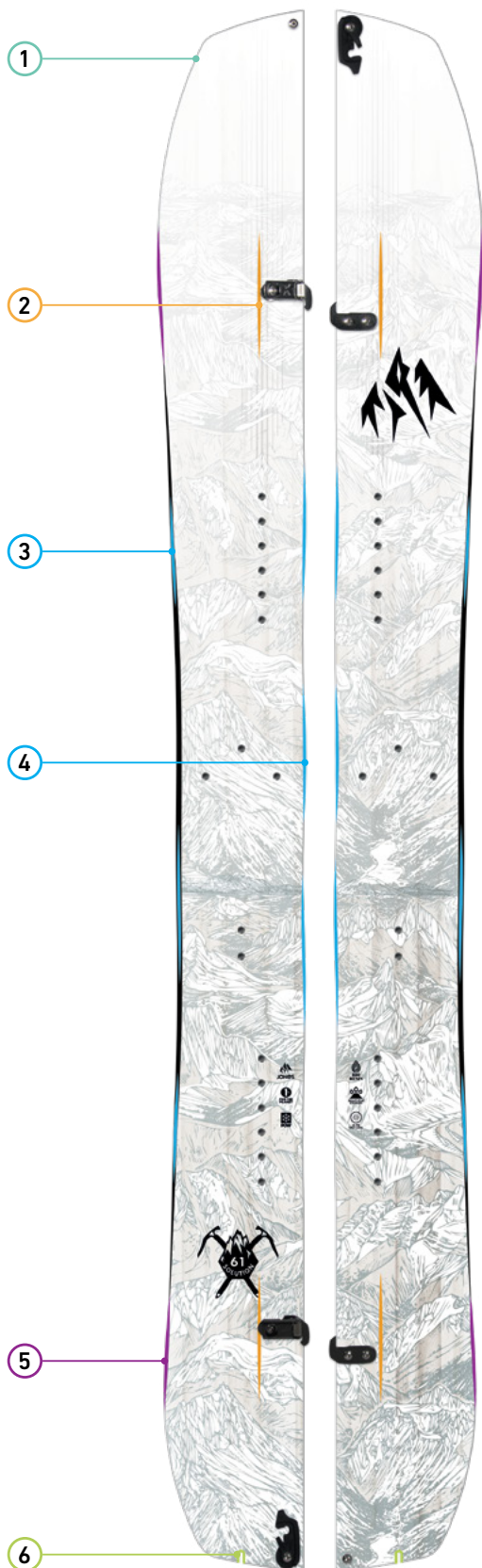

1 Blunt nose

"How a board glides in powder, crust, corn or any snow more than an inch deep, is dictated by it's front contact point and just past it. Next time you are in soft snow watch how much snow comes over the corner of the nose near the contact point. The billowing snow coming out from behind the tip means you are plowing through it which is obviously slowing you down. By adding a blunt nose you get the float benefits of a much longer nose without the 'snow plow' rounded tip and it's extra swing weight."

– Jeremy Jones

2 Boltless bridge

The Boltless Bridge eliminates split clip attachment hardware from the base of the board by re-profiling the wood core at the clips. The wood core under the clips is thicker providing better torsional stiffness and a more powerful connection at the split clips.

3 Traction Tech

Like a serrated knife slicing into the snow, Traction Tech improves your edge grip by adding multiple contact points along the running length of your board.

"Traction Tech is a critical feature for rockered boards. Rocker improves glide in mixed conditions, but the decreased edge contact makes it harder to really lock into your turns and hold a solid edge. Traction Tech is crucial to offset the edge drift of rocker."

– Jeremy Jones

4 Inner edge Traction Tech

Inner edge Traction Tech improves splitboard edge grip on ascent. Three side cut "bumps" on each side of your bindings keep you locked in on icy skin tracks no matter which way you are traversing.

5 Progressive sidecut

At the far ends of the sidecut, the radius is incrementally increased as the edge reaches the contact point. Gradually increasing the sidecut radius towards the contact point delivers smoother turn initiation and exit as the edge tracks in and out of the snow with a less abrupt transition.

6 Quick tension tail

Built-in climbing skin tension system using pre-cut notch that eliminates the need for a traditional skin tail clip.





CRAFTED FOR ALL STYLES, ABILITIES, AND TERRAIN

Snowboards

Our mission is to design the ultimate snowboards with industry leading sustainable manufacturing practices.

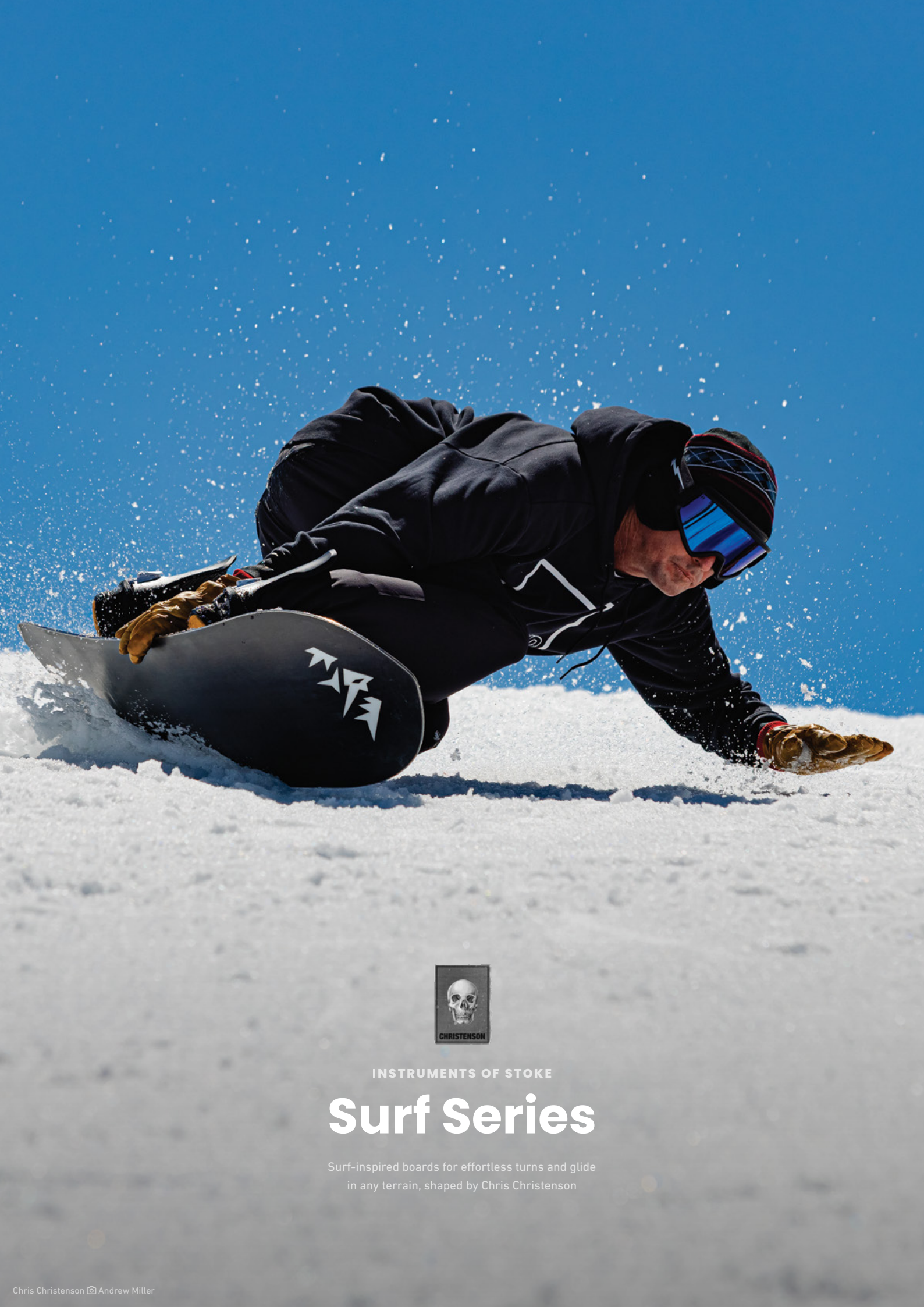

INSTRUMENTS OF STOKE

Surf Series

Surf-inspired boards for effortless turns and glide
in any terrain, shaped by Chris Christenson

TwinCraft

The floaty freestyle powder twin

Surfy freestyle, playful, volume-shifted

Ideal for slashin' pow, poppin' pillows and tossin' tricks



The TwinCraft is a new hybrid board that blends the performance of a volume-shifted powder shape with the fun freestyle characteristics of a twin.

- Medium flex for friendly control
- Extra wide twin outline for powder x freestyle
- True Camber + Pow Kicks for float and pop

Terrain



Shape Tech

Shape	Profile	Personality/Flex
Directional Twin	True Camber	Happy medium - 3/5

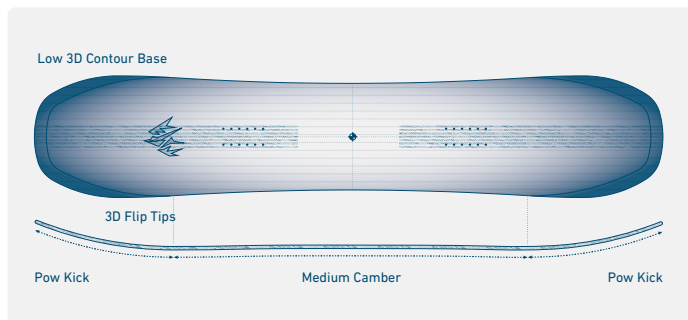

SIZE	146	150	154	158	162
W.W.	25.6	26.0	26.4	26.8	27.2
S.	6.3	6.5	6.7	6.9	7.1

Technology

Bcomp Carbon Flax Stringer
 Master Core **UPDATED**
 Biax Fiberglass
 Sintered 8000 Base
 Premium Topsheet
 Size 146 : 5.3 lbs / 2.4 kg

Mind Expander 2.0

The reimagined alternative all-mountain shredder

Friendly surf slasher, easy to turn, floaty

Ideal for creative freeriding and all-terrain flow



The Mind Expander 2.0 features a redesigned shape, camber profile and 3D Base Contour for effortless float in deep snow and improved all-terrain versatility.

- Medium flex for friendly control
- Tapered shape and dual radius sidecut for nimble control
- Directional Camber/Rocker for float and response

Terrain



Shape Tech

Shape	Profile	Personality/Flex
Directional	Dir. Camber / Rocker	Happy medium - 3/5

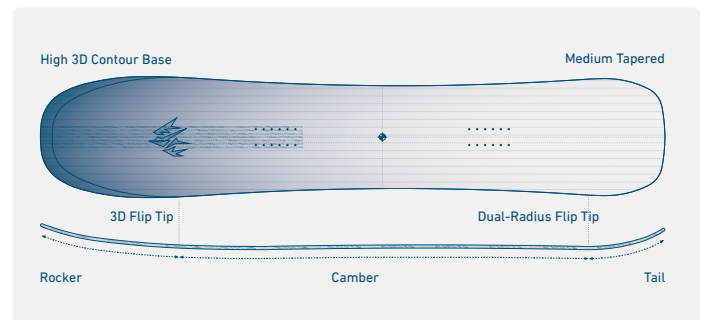

SIZE	142	146	150	154	158	162	166
W.W.	24.8	25.1	25.4	25.7	26.0	26.4	26.8
S.	6.6/6.0	6.8/6.2	7.0/6.4	7.2/6.6	7.4/6.8	7.6/7.0	7.8/7.2

Technology

Bcomp Carbon Flax Stringer
 Master Core **UPDATED**
 Biax Fiberglass
 Sintered 8000 Base
 Premium Topsheet
 Size 142 : 5.3 lbs / 2.4 kg

Storm Chaser

Surf-inspired powder slasher

Nimble swallowtail, surf slasher, floaty

Ideal for surfing frozen waves and snorkel deep days



The Storm Chaser is a power-packed swallowtail with a compact shape that offers magical float in pow and radical carving potential.

- Medium flex for friendly control
- Tapered directional shape for nimble float
- Surf Rocker profile for pow performance

Terrain



Shape Tech

Shape	Profile	Personality/Flex
Directional	Dir. Camber / Rocker	Happy medium - 3/5

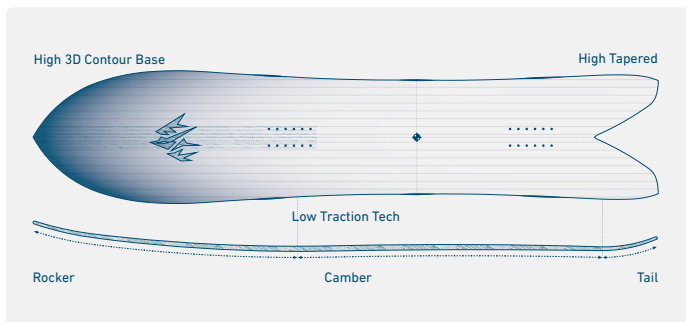

SIZE	142	147	152	157
W.W.	26.6	27.1	27.5	27.7
S.	6.3	6.6	6.9	7.2

Technology

- Bcomp Carbon Flax Stringer
- Master Core UPDATED
- Biax Fiberglass
- Sintered 8000 Base
- Premium Topsheet
- Size 152 : 6.4 lbs / 2.9 kg

Storm Wolf

The slicing and dicing speed arrow

Powerful swallowtail, surf slasher, floaty

Ideal for high speed slashing in any condition

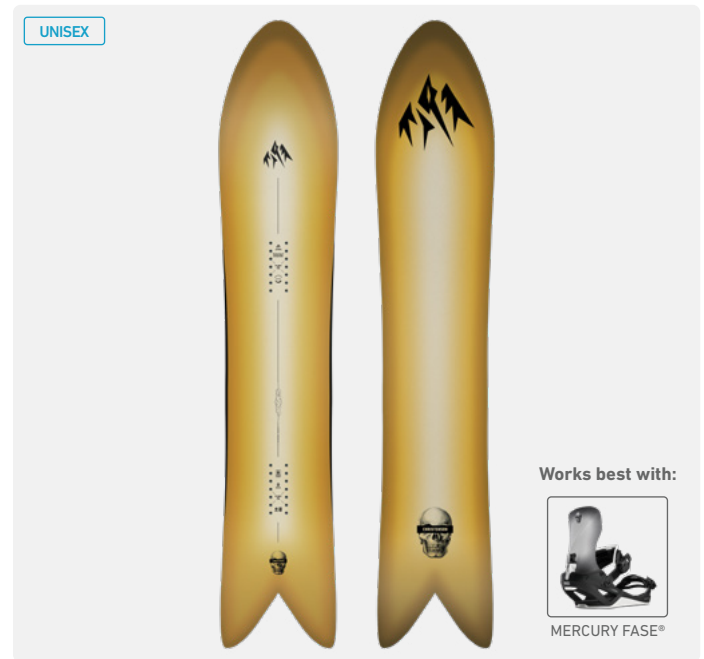

The Storm Wolf is a high-powered swallowtail that blends the all-mountain versatility of a directional freeride board with Surf Series turn performance.

- Mid-stiff flex for power and control
- Tapered directional shape for nimble float
- Surf Camber profile for power and grip

Terrain



Shape Tech

Shape	Profile	Personality/Flex
Directional	Dir. Camber / Rocker	Mid-stiff & lively - 4/5

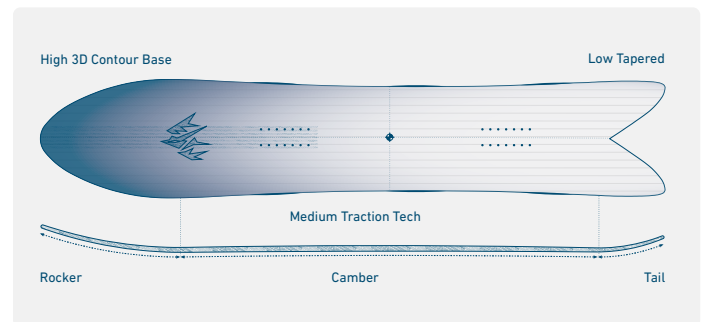

SIZE	150	154	158	162
W.W.	25.9	26.1	26.2	26.4
S.	8.2	8.4	8.6	8.8

Technology

- Bcomp Carbon Flax Stringer
- Master Core UPDATED
- Biax Fiberglass
- Sintered 8000 Base
- Premium Topsheet
- Carve Pack
- Size 158 : 6.6 lbs / 3 kg

Mountain Surfer

Next level surf sled

Pow surfer, no bindings, floaty

Ideal for powder surfing and backyard exploration

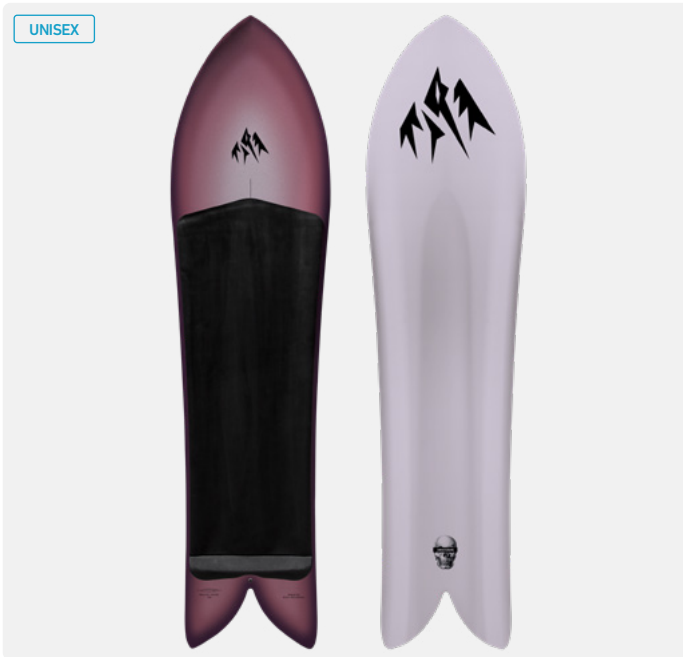

The Mountain Surfer is a next level powsurfing board built to surf the earth without bindings.

- 3D stepped edges that lock in turns
- Tapered directional shape for max float
- Surf Rocker profile for pow performance

Terrain



Shape Tech

Shape	Profile	Personality/Flex
Directional	Christenson Surf Rocker	Happy medium - 3/5

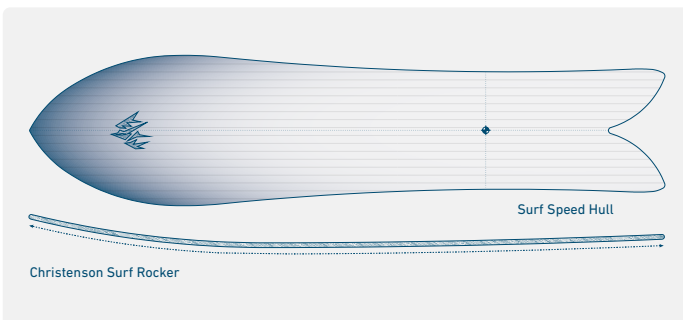

Features

Premium Core	Size 152 : 7,4 lbs / 3,4 kg
Triax Fiberglass	
Sintered 8000 Base	

Sizes

Available in: 142 / 152



BUILT TO CARVE

Freecarver Series

High powered true camber all-mountain carving boards designed to help you carve the best turns of your life.

Freecarver 6000s

The playful all-mountain carver

All-mountain carving, camber, tight turns
Ideal for carving tight turns and all-mountain slashing

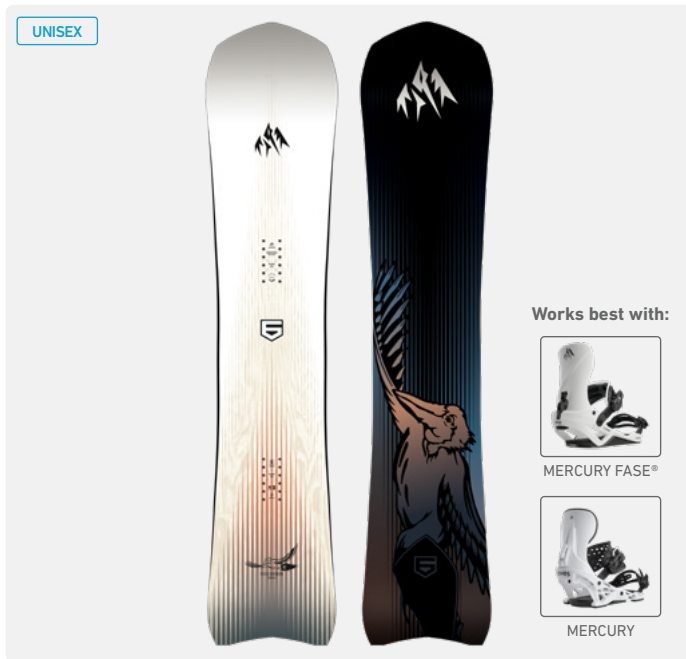

The Freecarver 6000s is a carvingspecific board featuring a full camber profile designed for making tight turns and slashing around the mountain.

- Short sidecut for carving tight turns
- Medium flex for friendly control
- Long effective edge for max carving power

Terrain



Shape Tech

Shape	Profile	Personality/Flex
Directional	True Camber	Happy medium - 3/5

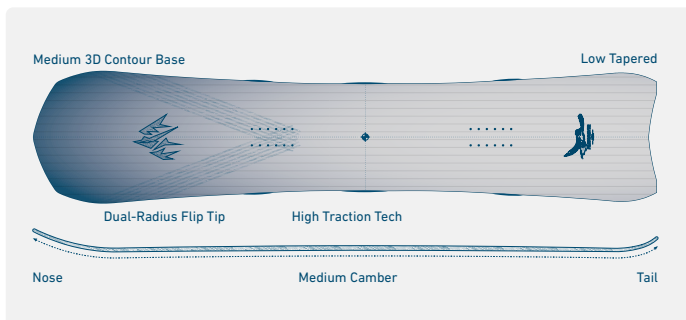

SIZE	150	150N	154	154N	158	158N	162
W.W.	26.1	24.6	26.3	24.8	26.5	25	26.7
S.	6.2	6.2	6.5	6.5	6.7	6.7	6.9

Technology

- Bcomp Carbon Flax Stringer
- Power Core
- Biax Fiberglass
- Sintered 8000 Base
- Premium Topsheet **UPDATED**
- Size 154 : 6,6 lbs / 3 kg

Freecarver 9000s

The powerful all-mountain carver

All-mountain carving, camber, big turns
Ideal for high speed carving and all-mountain charging

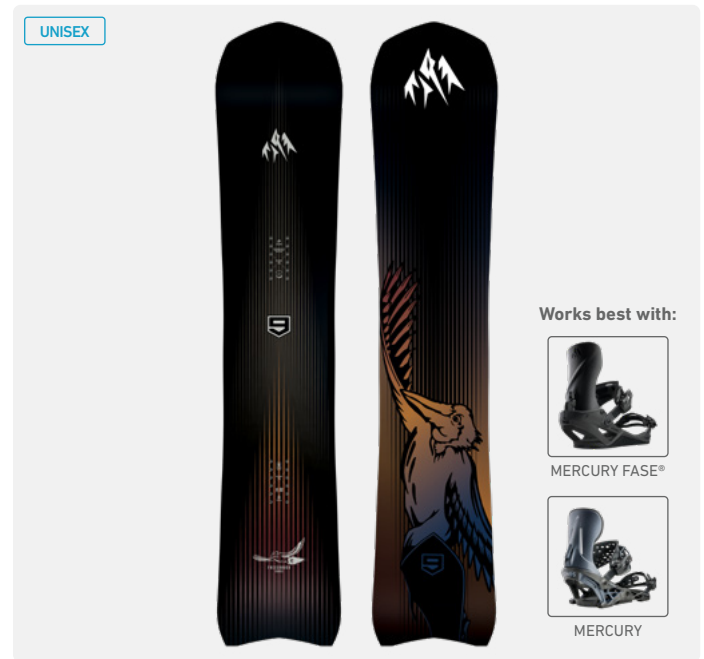

The Freecarver 9000s is a carving-specific board featuring a full camber profile that's specifically designed for locking into massive turns at high speeds.

- Long sidecut for carving big turns
- Mid-stiff flex for stability at speed
- Long effective edge for max carving power

Terrain



Shape Tech

Shape	Profile	Personality/Flex
Directional	True Camber	Mid-stiff & lively - 4/5

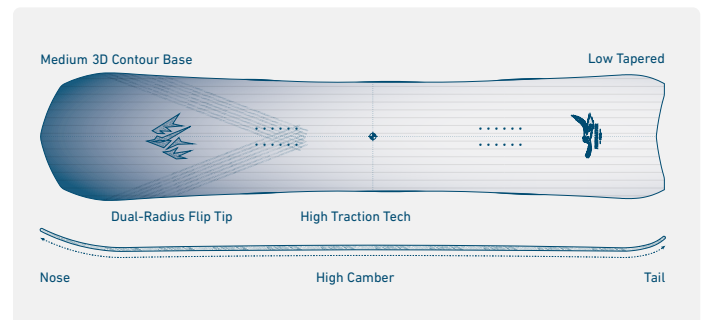

SIZE	152	152N	156	156N	160	164
W.W.	26.8	24.8	27.0	25	27.2	27.4
S.	9.0	9.0	9.2	9.2	9.4	9.6

Technology

- Bcomp Carbon Flax Stringer
- Power Core
- Triax Fiberglass
- Sintered 8000 Base
- Premium Topsheet **UPDATED**
- Size 156 : 6,8 lbs / 3,1 kg





HIGH PERFORMANCE DESIGNS BUILT FOR DYNAMIC DESCENTS

Men's All-Mountain Freeride

Directional shapes that maximize float, speed and response for supreme freeride performance and all-mountain versatility.

Men's Ultralight Project X

Flyweight all-mountain razor

Lightweight, all-mountain, snappy, energetic

Ideal for all-conditions, carving, cruising, and freeriding



The Ultralight Project X is an ultralight all-mountain board that rides like a luxury sport sedan - powerful, with impeccable handling and a comfortable flex.

- Fusion Carbon construction to reduce weight
- Medium flex for friendly control
- Tapered shape + short sidecut for quick turns

Terrain



Shape Tech

Shape	Profile	Personality/Flex
Directional	Dir. Camber / Rocker	Happy medium - 3/5

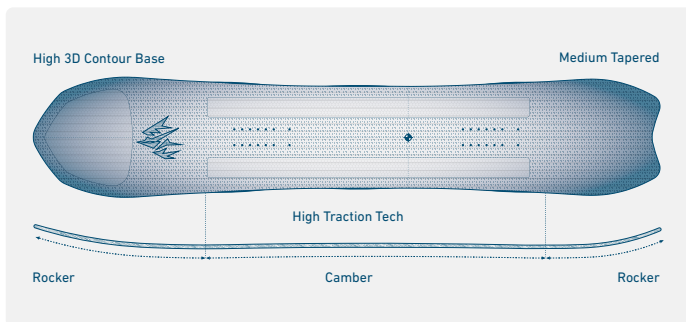

SIZE	156	159	161W
W.W.	25.4	25.6	26.4
S.	7.2	7.5	7.7

Technology

Koroyd®	Float Pack	Size 156 : 5,5 lbs / 2,5 kg
Fusion Carbon	Ultra Base	
Fusion core	Ultralight Eco Topsheet	

Men's Flagship Pro

Only for the expert freerider

All-conditions freeride, experts only, stiff

Ideal for high-speed freeriding and extreme terrain



The Flagship Pro is a seriously stiff, competition-ready freeride board designed for expert freeriders who like to crush steep terrain at top speed.

- Stiff flex for power and response
- Tapered directional shape for nimble float
- Directional rocker profile for float and grip

Terrain



Shape Tech

Shape	Profile	Personality/Flex
Directional	Dir. Camber / Rocker	Stiff & Powerful - 5/5

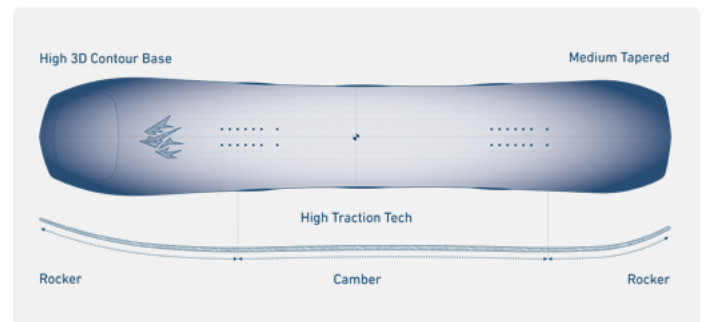

SIZE	154	158	159W	161	162W	164	165W
W.W.	24.6	24.9	26.3	25.2	26.3	25.4	26.6
S.	7.9	8.5	8.7	9.1	9.3	9.3	9.4

Technology

Koroyd®	Float Pack	Size 158 : 6 lbs / 2,7 kg
Basalt Pro Layout NEW	Sintered 9900 Base UPDATED	
Power Core	Premium Topsheet UPDATED	

Men's Flagship

The freeride foundation

All-conditions freeride, stable, floaty
Ideal for freeriding and fall-line freestyle



Works best with:



MERCURY FASE®



MERCURY

The Flagship is a high powered freeride board that excels in technical terrain and is one the most confidence-inspiring snowboards on the planet.

- Mid-stiff flex for power and control
- Tapered directional shape for nimble float
- Directional rocker profile for float and grip

Terrain



Shape Tech

Shape	Profile	Personality/Flex
Directional	Dir. Camber / Rocker	Mid-stiff & lively - 4/5

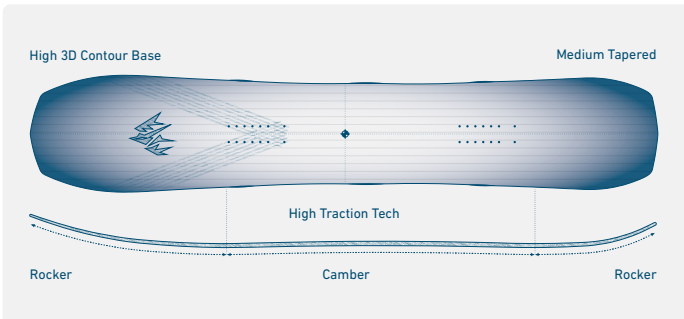

SIZE	151	154	156W	158	159W	161	162W	164	165W	167	169W	172
W.W.	24.3	24.6	26.1	24.9	26.3	25.2	26.3	25.4	26.6	25.9	27.0	26.3
S.	7.3	7.9	8.3	8.5	8.7	9.1	9.3	9.3	9.4	9.4	9.5	9.5

Technology

Bcomp Carbon Flax Stringer	Sintered 8000 Base UPDATED	Size 158 : 6.5 lbs / 2,9 kg
Control Core UPDATED	Float Pack	
Triax Fiberglass	Ash Wood Veneer	

Men's Howler

The creative freerider's favorite

Freeride x freestyle, full camber, stable, poppy
Ideal for technical freeriding and freestyle



Works best with:



MERCURY FASE®

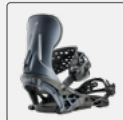

MERCURY

The Howler is a next-generation directional freeride board designed by Victor de Le Rue and Elena Hight that turns steep, technical terrain into your playground.

- Mid-stiff flex for power and control
- Tapered directional shape for nimble float
- High full camber profile for improved grip and trick stomping

Terrain



Shape Tech

Shape	Profile	Personality/Flex
Directional	High Power Camber	Mid-stiff & lively - 4/5

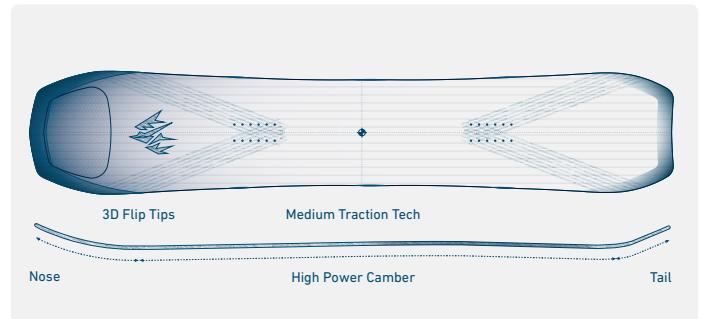

SIZE	152	155	157W	158	160W	161	163W	164
W.W.	25.1	25.4	26.4	25.7	26.7	26	27	26.3
S.	8	8.2	8.4	8.4	8.6	8.6	8.8	8.8

Technology

Koroyd®	Triax Fiberglass	Size 155 : 5,9 lbs / 2,7 kg
Bcomp Carbon Flax Stringer	Sintered 8000 Base	
Power Core	Premium Topsheet UPDATED	

Men's Stratos

The versatile all-terrain freerider

All-conditions freeride, versatile, energetic
Ideal for dynamic freeriding and all-mountain ripping

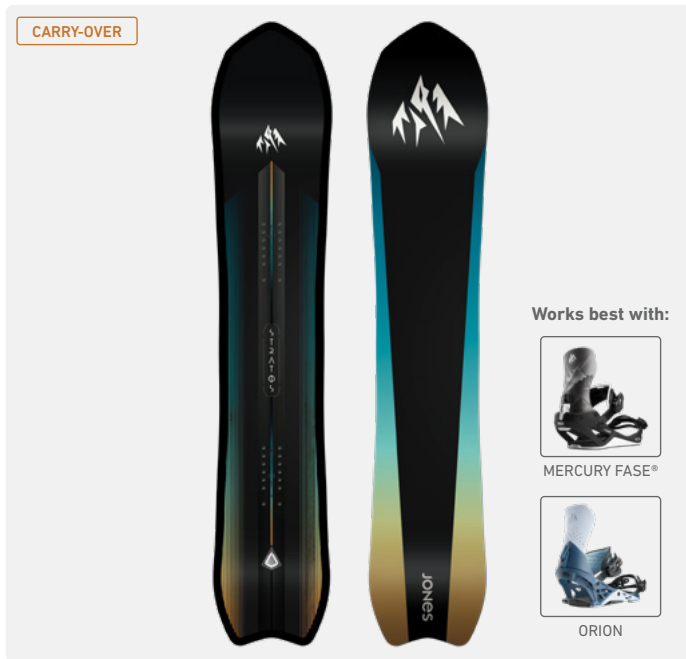

The Men's Stratos is a hybrid all-mountain board featuring a directional freeride shape and an energetic and playful board feel.

- Mid-stiff flex for power and control
- Tapered directional shape for nimble float
- Directional rocker profile for float and grip

Terrain



Shape Tech

Shape	Profile	Personality/Flex
Directional	Dir. Camber / Rocker	Happy medium - 3/5

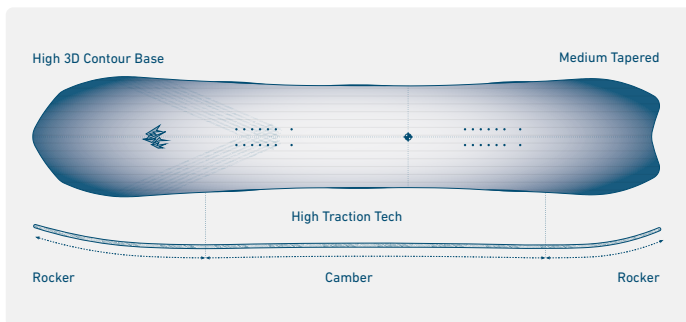

SIZE	149	153	154W	156	158W	159	161W	162	164W
W.W.	24.2	24.8	26.1	25.4	26.3	25.6	26.4	25.8	26.5
S.	6.5	6.8	7.1	7.2	7.4	7.5	7.7	7.8	8.0

Technology

Bcomp Carbon Flax Stringer	Sintered 8000 Base	Float Pack
Power Core	Flip-Flop Base	Size 156 : 6,5 lbs / 2,9 kg
Biax Fiberglass	Premium Topsheet	

Hovercraft 2.0

The evolved all-conditions charger

All-conditions freeride, nimble, floaty
Ideal for pow slashing, crud busting and slaloming trees

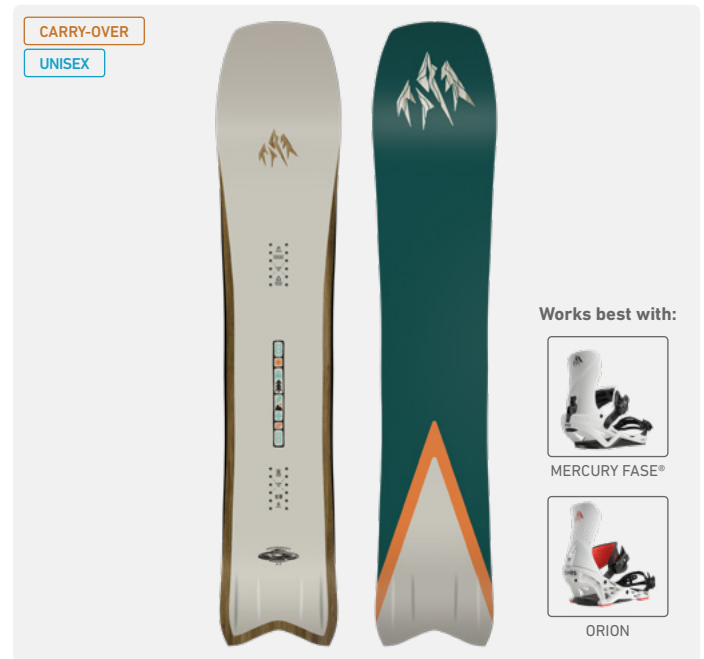

The Hovercraft 2.0 is a nimble and explosive alternative freeride board built with our most advanced 3D shape tech and cutting-edge recycled materials.

- Medium flex for friendly control
- Tapered directional shape for nimble float
- Directional rocker profile for float and grip

Terrain



Shape Tech

Shape	Profile	Personality/Flex
Directional	Dir. Camber / Rocker	Happy medium - 3/5

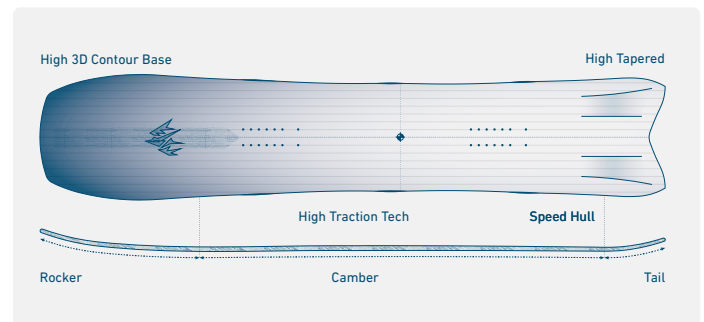

SIZE	144	148	152	156	160	164
W.W.	25.1	25.5	25.9	26.3	26.7	27.1
S.	8.1	8.4	8.7	9.0	9.3	9.6

Technology

Re-Up Tech Core	Flax Fiber UPDATED
Biax Fiberglass	Size 156 : 6,8 lbs / 3,1 kg
Sintered 8000 Base	

Men's Frontier 2.0

The all-terrain, shred anything board

Friendly freeride, easy-to-turn, floaty

Ideal for all-mountain freeriding and powder slashing

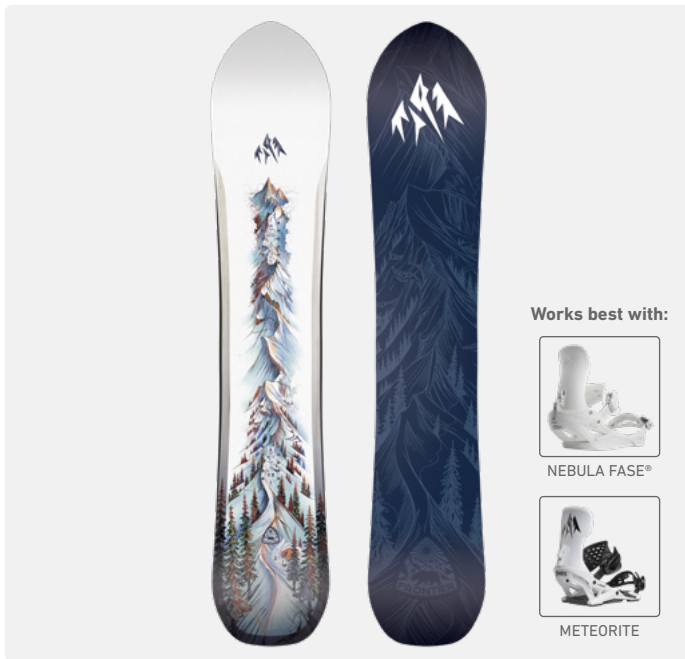

The Frontier 2.0 is an all-terrain, shred anything board with a tapered directional shape and a friendly flex that charges in all-conditions.

- Friendly flex for fun loving board feel
- Directional rocker profile with 3D Flip Tip for enhanced float and grip
- Short sidecut for easy slashing

Terrain



Shape Tech

Shape	Profile	Personality/Flex
Directional	Dir. Camber / Rocker	Friendly & playful - 2/5

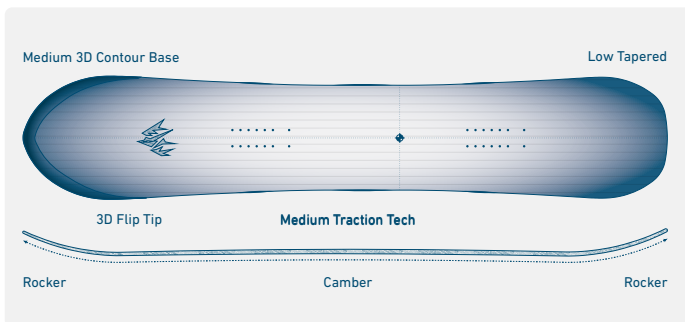

SIZE	150	153	155W	156	158W	159	161W	162	164W	165	167W
W.W.	24.6	24.9	26.3	25.2	26.5	25.5	26.7	25.8	26.9	26.1	27.1
S.	7.2	7.4	7.6	7.6	7.8	7.8	8	8	8.2	8.2	8.4

Technology

Master Core	Premium Topsheet
Biax Fiberglass	Size 156 : 6 lbs / 2,7 kg
Sintered 8000 Base	



ALL-AROUND PERFORMANCE, READY TO RIDE EVERYTHING

Men's All-Mountain

Directional Twin shapes built for maximum versatility on any terrain and in all conditions, made to ride every day of the season.

Men's Mountain Twin Pro

The ultimate all-mountain powerhouse

All-mountain twin, powerful, stable

Ideal for sending side hits, slashing pow and shredding groomers



The Mountain Twin PRO is a high-performance directional twin built for hard-charging riders who want maximum response and stability to push their limits anywhere on the mountain.

- Mid-stiff flex for power and control
- Directional twin shape for all-terrain charging
- CamRock profile for float and pop

Terrain



Shape Tech

Shape	Profile	Personality/Flex
Directional Twin	CamRock	Mid-stiff & lively - 4/5

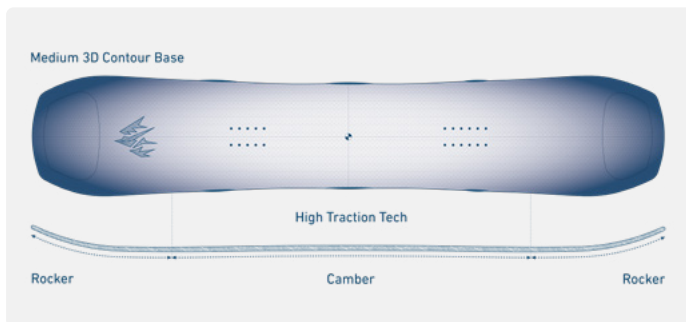

SIZE	154	156W	157	159W	160	162W	163	165W
W.W.	25.1	25.9	25.4	26.1	25.7	26.3	26.0	26.7
S.	7.6	7.7	7.8	7.9	8.0	8.1	8.2	8.3

Technology

Koroyd®	Recycled Sintered 9900 Base	Size 157 : 6.4 lbs / 2,9 kg
Basalt Pro Layup NEW	Premium Topsheet UPDATED	
Boost Core UPDATED	Freeride/Freestyle Pack	

Men's Mountain Twin

The definitive do-it-all snowboard

All-mountain twin, easy-to-turn, versatile

Ideal for slashing side hits, floating in pow, and ripping the resort

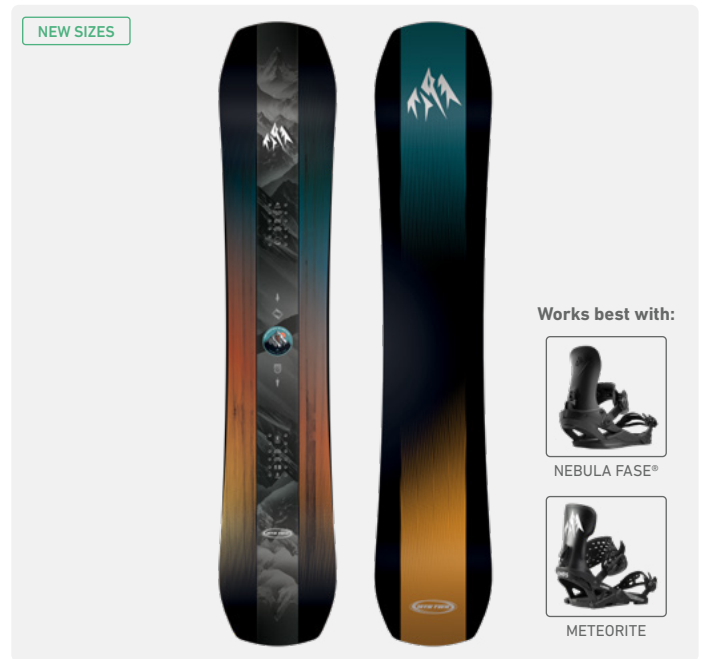

The Mountain Twin is an award-winning directional twin built for riders who want a versatile board that balances power and play, from carving groomers to slashing side hits and exploring the whole mountain.

- Medium flex for confident control
- Directional twin shape for all-terrain riding
- CamRock profile for float and pop

Terrain



Shape Tech

Shape	Profile	Personality/Flex
Directional Twin	CamRock	Happy Medium - 3/5

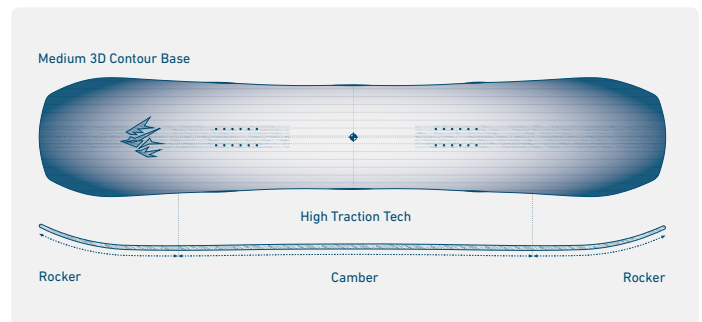

SIZE	149	151	153W	154	156W	157	158UW	159W	160	161UW	162W	163	164UW	165W	168W
W.W.	24.4	24.8	25.7	25.1	25.9	25.4	27.8	26.1	25.7	28	26.3	26.0	28.2	26.7	26.9
S.	7.2	7.4	7.5	7.6	7.7	7.8	7.8	7.9	8.0	8.0	8.1	8.2	8.2	8.3	8.5

Technology

Bcomp Carbon Flax Stringer	Sintered 8000 Base	Size 157 : 6.1 lbs / 2,8 kg
Master Core	Premium Topsheet	
Biax Fiberglass	Freeride/Freestyle Pack	

Men's Aviator 2.0

The precision tool for all-terrain performance

Powerful directional twin, full camber, stiff, poppy
Ideal for fast carves, big airs and rock-solid stability

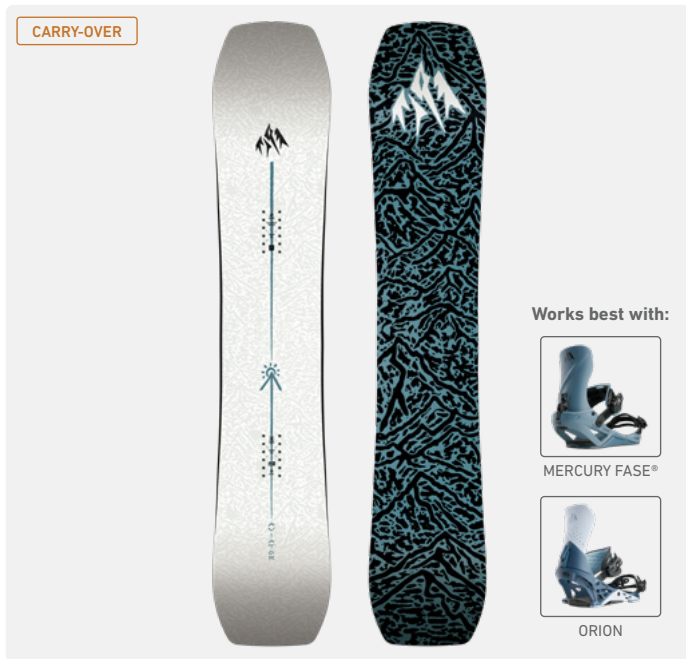

The Aviator 2.0 is a hard charging directional twin built for expert all-mountain riders who like to rail turns and stomp airs anywhere on the mountain.

- Mid-stiff flex for power and control
- Directional twin shape for freestyle and switch
- Full camber profile for edge power

Terrain



Shape Tech

Shape	Profile	Personality/Flex
Directional Twin	True Camber	Mid-stiff & lively - 4/5

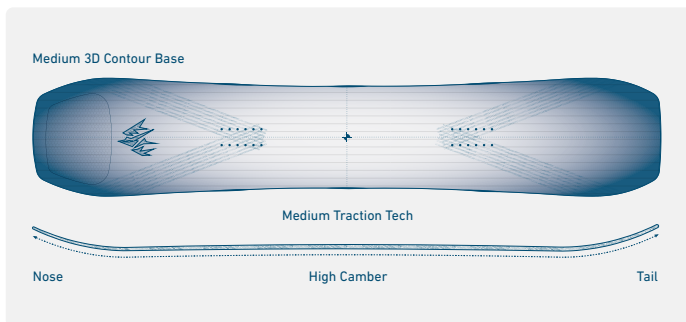

SIZE	147	150	153W	154	156	157W	158	159W	160	162	163W
W.W.	24.2	24.5	25.9	24.9	25.1	26.1	25.3	26.3	25.5	25.6	26.6
S.	7.1	7.3	7.4	7.5	7.6	7.7	7.7	7.9	7.9	8.2	8.4

Technology

Koroyd®	Triax Fiberglass	Size 156 : 6,3 lbs / 2,9 kg
Bcomp Carbon Flax Stringer	Sintered 8000 Base	
Boost Core	Premium Eco Topsheet	

Men's Rally Cat

The all-mountain fun seeker

Friendly cruiser, easy-to-turn, playful
Ideal for all-resort fun, carving, and slashing pow

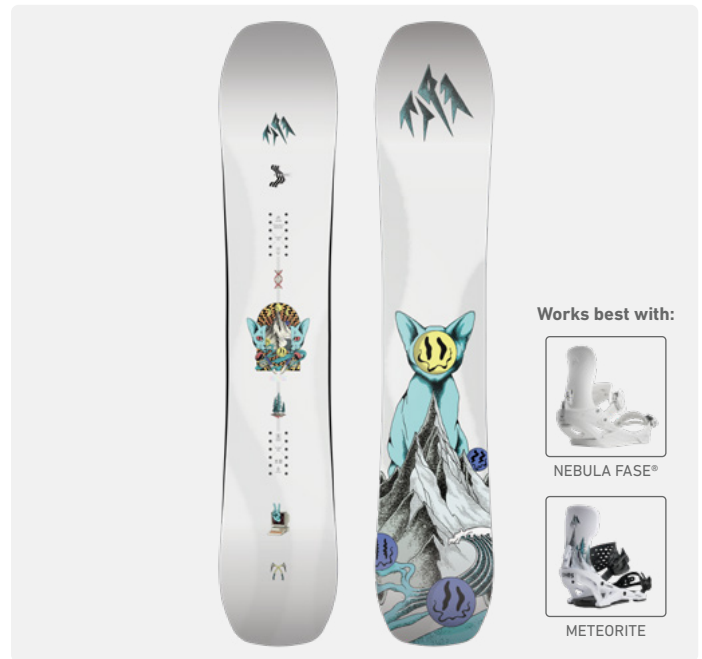

The Rally Cat is a rider-favorite directional twin that delivers smooth, responsive performance, making every turn, carve, and pow slash feel effortless across the mountain.

- Friendly flex for fun loving board feel
- Directional twin shape for all-terrain
- Full camber profile for edge power

Terrain



Shape Tech

Shape	Profile	Personality/Flex
Directional Twin	True Camber	Friendly & Playfull - 2/5

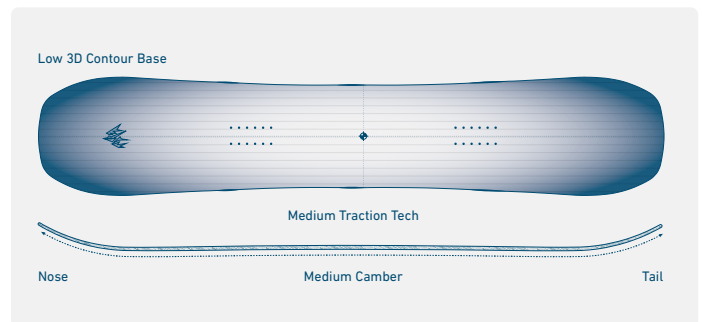

SIZE	151	154	155W	156	158	159W	161	162W	166W	170W
W.W.	24.7	25.0	25.8	25.2	25.4	26.3	25.7	26.5	26.7	26.9
S.	7.0	7.3	7.4	7.5	7.7	7.8	8.0	8.2	8.6	8.9

Technology

Master Core	Premium Topsheet
Biax Fiberglass	Size 156 : 5,8 lbs / 2,7 kg
Sintered 8000 Base	



FREESTYLE SPIRIT, ALL-MOUNTAIN SOUL

Men's All-Mountain Freestyle

True Twin shapes built for popping, pressing, spinning, slashing and creative riding across the whole mountain.

Men's Tweaker Pro 2.0

The supercharged freestyler, reimagined

Freestyle twin, poppy, powerful, full camber
Ideal for expert freestyle and all-terrain slashing

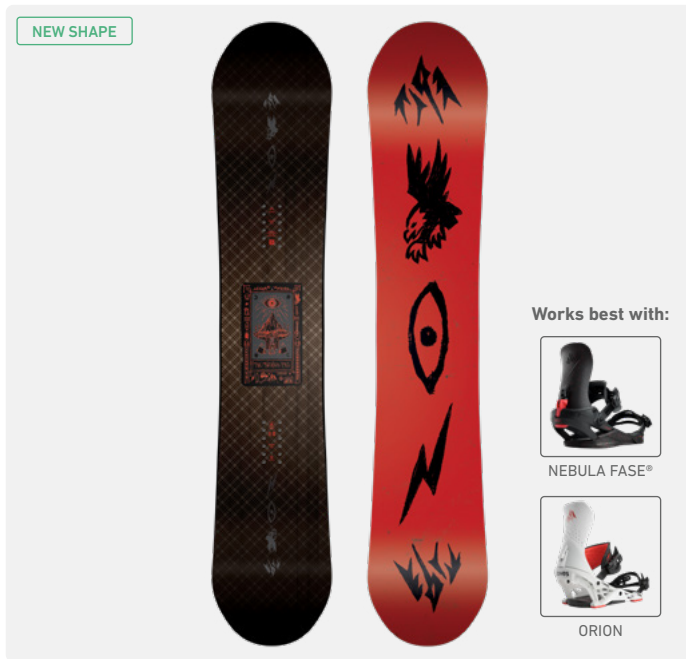

The Tweaker Pro 2.0 is a supercharged true twin featuring a full camber profile that's built for high speed terrain park trickery and ripping lines in any terrain.

- Mid-stiff flex for stomping and tweaking
- Updated true twin shape for freestyle and switch
- High camber profile for ultimate pop and edge power

Terrain



Shape Tech

Shape	Profile	Personality/Flex
True Twin	True Camber	Mid-stiff & lively - 4/5

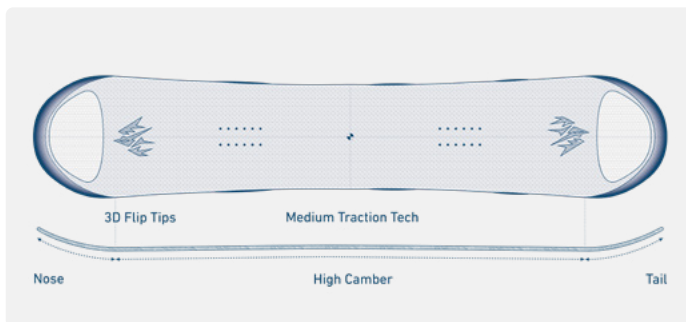

SIZE	149	151	154	156	157W	159
W.W.	24.8	25	25.2	25.4	26.3	25.7
S.	7.3	7.4	7.5	7.6	7.7	7.7

Technology

Koroyd®
Basalt Pro Layup **NEW**
Boost Core

Sintered 8000 Base
Premium Topsheet

Size 156 : 6,4 lbs / 2,9 kg

Men's Tweaker 2.0

The updated fun hoggin' freestyler

All-mountain freestyle, poppy, playful, full camber
Ideal for all-mountain freestyle, creative side hits, and flowy lines

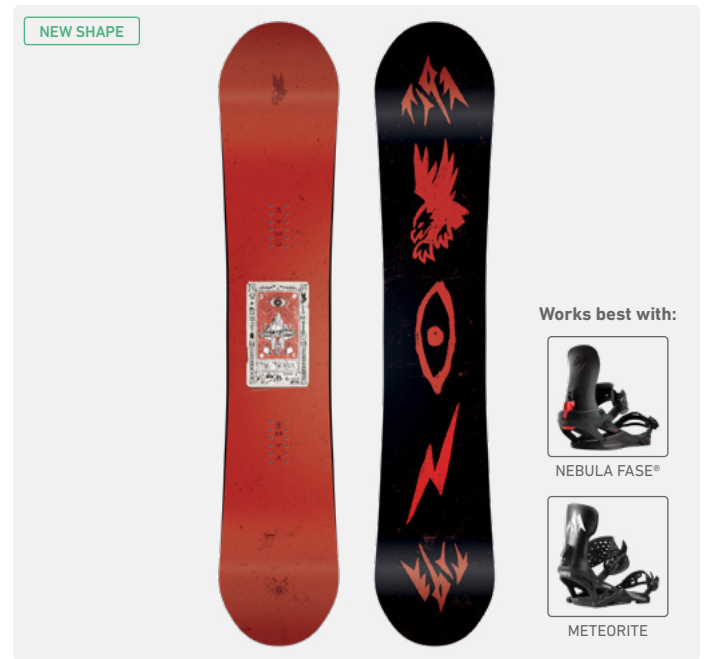

The Tweaker 2.0 is an all-mountain freestyle true twin featuring a full camber profile, built to pop ollies, slash side hits, toss tricks, and carve creative lines in any terrain.

- Friendly flex for fun loving board feel
- Updated true twin shape for freestyle and switch
- Medium camber profile for pop and edge power

Terrain



Shape Tech

Shape	Profile	Personality/Flex
True Twin	True Camber	Friendly & playful - 2/5

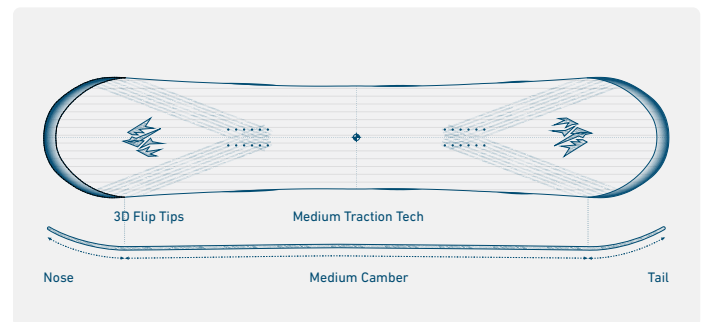

SIZE	149	151	154	156	157W	159	160W	162
W.W.	24.8	25	25.2	25.4	26.3	25.7	26.6	26.0
S.	7.3	7.4	7.5	7.6	7.7	7.7	7.8	7.8

Technology

Bcomp Carbon Flax Stringer
Master Core
Biax Fiberglass

Sintered 8000 Base
Premium Topsheet

Size 156 : 6,2 lbs / 2,8 kg



HIGH PERFORMANCE DESIGNS BUILT FOR DYNAMIC DESCENTS

Women's All-Mountain Freeride

Directional shapes that maximize float, speed and response for supreme freeride performance and all-mountain versatility.

Women's Flagship

The ultimate freeride board

All-conditions freeride, stable, floaty

Ideal for confident freeriding in all terrain and all conditions

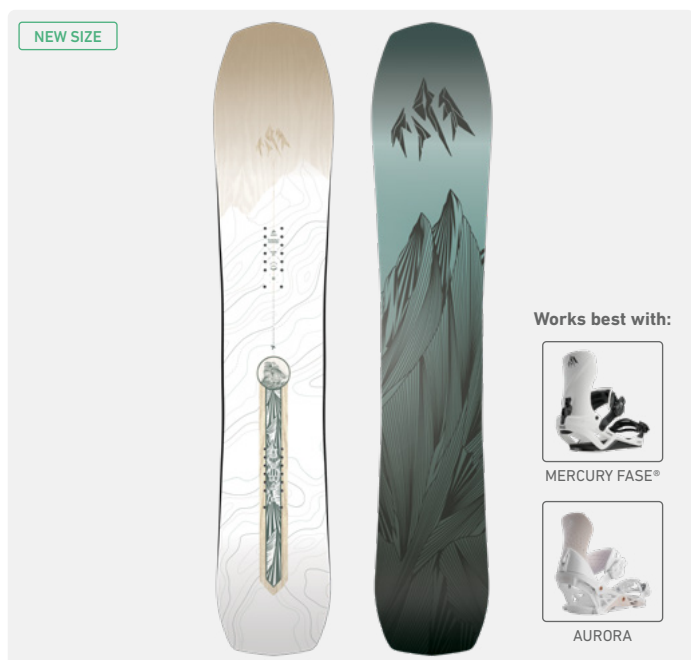

The Women's Flagship is a high powered freeride board that excels in technical terrain and is one of the most confidence inspiring snowboards on the planet.

- Mid-stiff flex for power and control
- Tapered directional shape for nimble float
- Directional rocker profile for float and grip

Terrain



Shape Tech

Shape	Profile	Personality/Flex
Directional	Dir. Camber / Rocker	Mid-stiff & lively - 4/5

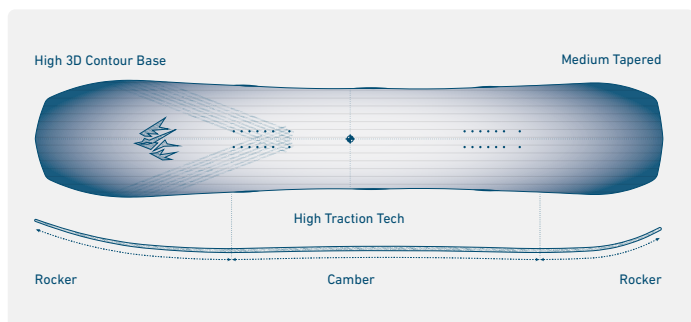

SIZE	143	146	149	152	155
W.W.	23.5	23.7	23.9	24.1	24.3
S.	6.9	7.1	7.3	7.5	7.8

Technology

Bcomp Carbon Flax Stringer	Sintered 8000 Base	Size 149 : 5.4 lbs / 2.5 kg
Control Core	Float Pack	
Triax Fiberglass	Ash Wood Veneer	

Women's Howler

The creative freerider's favorite

Freeride x freestyle, full camber, stable, poppy

Ideal for technical freeriding and freestyle

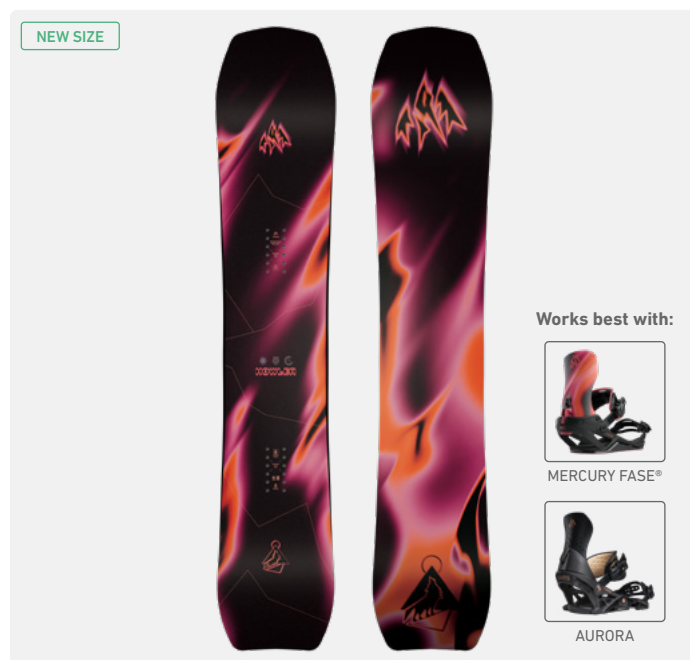

The Howler is a next-generation directional freeride board designed by Victor de Le Rue and Elena Hight that's built to turn steep, technical terrain into your playground.

- Mid-stiff flex for power and control
- Tapered directional shape for nimble float
- High full camber profile for improved grip and trick stomping

Terrain



Shape Tech

Shape	Profile	Personality/Flex
Directional	High Power Camber	Mid-stiff & lively - 4/5

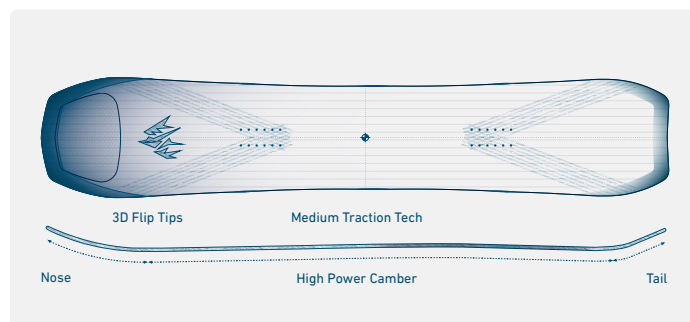

SIZE	142	145	148	151
W.W.	24.1	24.3	24.5	24.7
S.	7.2	7.4	7.6	7.8

Technology

Koroyd®	Triax Fiberglass	Size 148 : 5.3 lbs / 2.4 kg
Bcomp Carbon Flax Stringer	Sintered 8000 Base	
Power Core	Premium Eco Topsheet	

Women's Stratos

The versatile all-terrain freerider

All-conditions freeride, versatile, energetic
Ideal for dynamic freeriding and all-mountain ripping

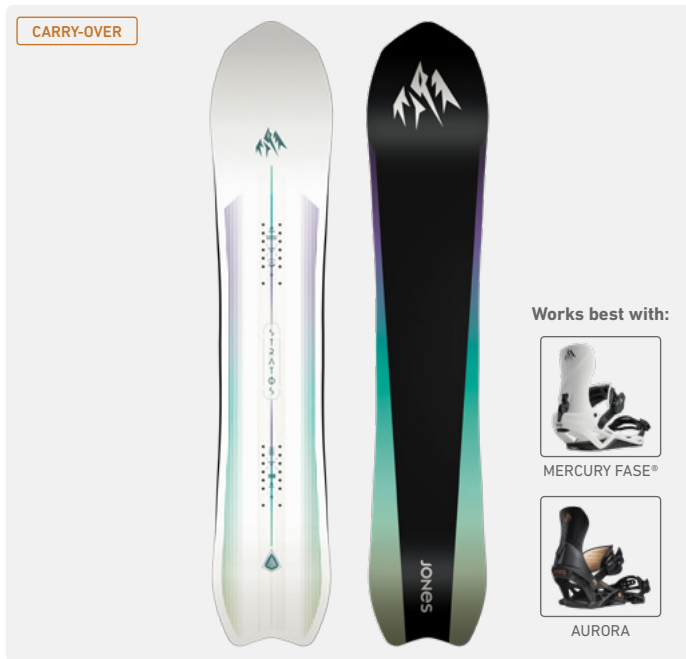

The Women's Stratos is a hybrid all-mountain board featuring a directional freeride shape and an energetic and playful board feel.

- Medium flex for confident control
- Tapered directional shape for nimble float
- Directional rocker profile for float and grip

Terrain



Shape Tech

Shape	Profile	Personality/Flex
Directional	Dir. Camber / Rocker	Happy medium - 3/5

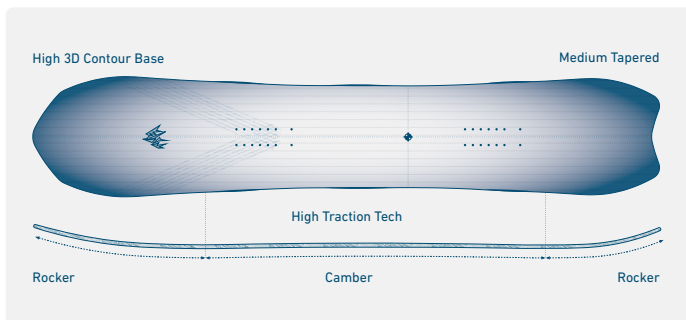

SIZE	140	143	146	149	152	155
W.W.	23.3	23.6	23.9	24.2	24.4	24.7
S.	5.9	6.1	6.3	6.5	6.7	6.9

Technology

- Bcomp Carbon Flax Stringer
- Power Core
- Biax Fiberglass
- Sintered 8000 Base
- Flip-Flop Base
- Premium Topsheet
- Float Pack
- Size 149 : 5,6 lbs / 2,6 kg

Women's Dream Weaver 2.0

The playful charger

Friendly freeride, easy-to-turn, floaty
Ideal for all-mountain freeriding and powder slashing



The Dream Weaver 2.0 is an all-terrain, shred anything board with a tapered directional shape and a friendly flex that charges in all-conditions.

- Friendly flex for fun loving board feel
- Tapered directional shape for nimble float
- Directional rocker profile with 3D Flip Tips for enhanced float and grip

Terrain



Shape Tech

Shape	Profile	Personality/Flex
Directional	Dir. Camber / Rocker	Friendly & playful - 2/5

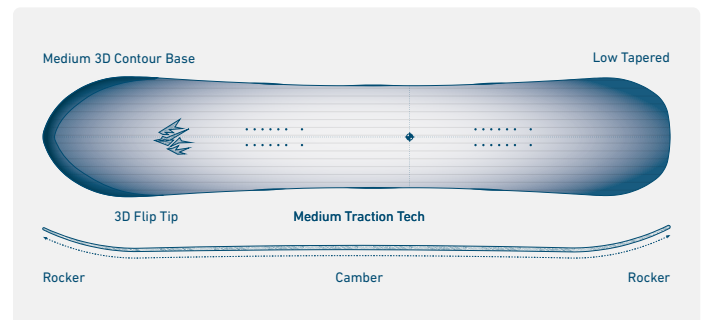

SIZE	139	142	145	148	151	154	156
W.W.	23.5	23.7	23.9	24.1	24.3	24.5	24.7
S.	6.5	6.7	6.9	7.1	7.3	7.5	7.7

Technology

- Master Core
- Biax Fiberglass
- Sintered 8000 Base
- Premium Topsheet
- Size 148 : 5 lbs / 2,3 kg

Hovercraft 2.0

The evolved all-conditions charger

All-conditions freeride, nimble, floaty

Ideal for pow slashing, crud busting and slaloming trees

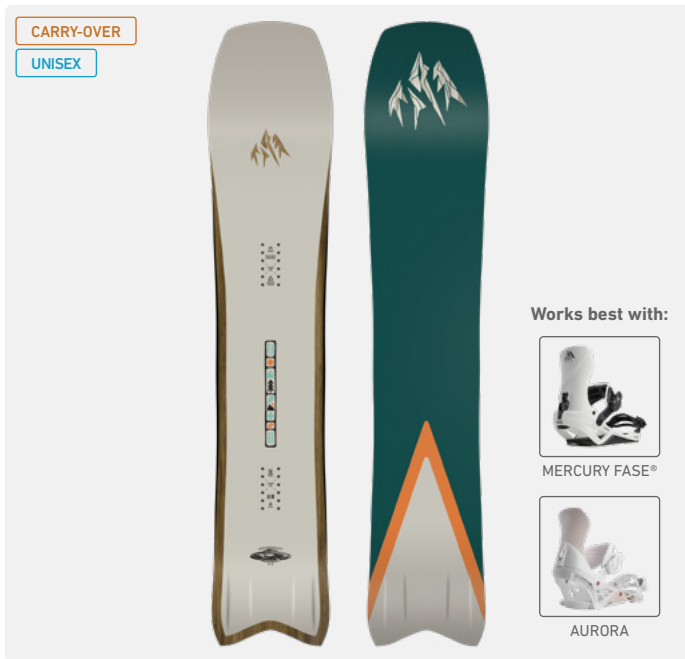

The Hovercraft 2.0 is a nimble and explosive alternative freeride board built with our most advanced 3D shape tech and cutting-edge recycled materials.

- Medium flex for friendly control
- Tapered directional shape for nimble float
- Directional rocker profile for float and grip

Terrain



Shape Tech

Shape	Profile	Personality/Flex
Directional	Dir. Camber / Rocker	Happy medium - 3/5

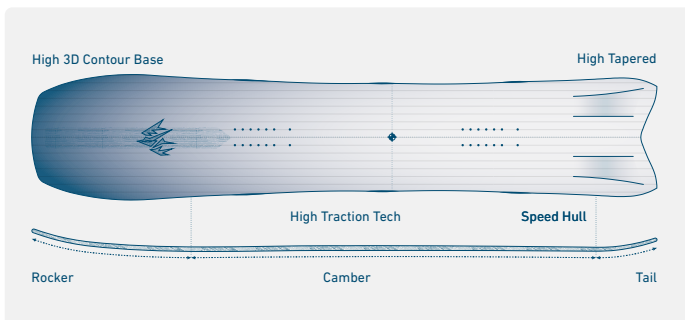

SIZE	144	148	152	156	160	164
W.W.	25.1	25.5	25.9	26.3	26.7	27.1
S.	8.1	8.4	8.7	9.0	9.3	9.6

Technology

- Re-Up Tech Core
- Biax Fiberglass
- Sintered 8000 Base
- Flax Fiber UPDATED
- Size 156 : 6,8 lbs / 3,1 kg



ALL-AROUND PERFORMANCE, READY TO RIDE EVERYTHING

Women's All-Mountain

Directional Twin shapes built for maximum versatility on any terrain and in all conditions, made to ride every day of the season.

Women's Airheart 2.0

The precision tool for all-terrain performance

Powerful directional twin, full camber, stiff, poppy
Ideal for fast curves, big airs and rock-solid stability



The Airheart 2.0 is a hard-charging directional twin built for advanced all-mountain riders who like to carve turns and catch air anywhere on the mountain.

- Mid-stiff flex for power and control
- Directional twin shape for freestyle and switch
- Full camber profile for edge power

Terrain



Shape Tech

Shape	Profile	Personality/Flex
Directional Twin	True Camber	Mid-stiff & lively - 4/5

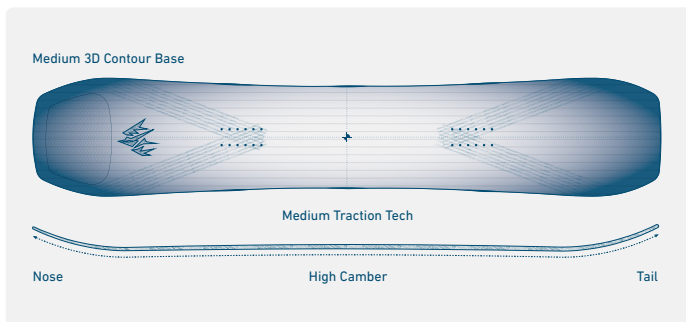

SIZE	143	146	149	152	155
W.W.	23.6	23.8	24.0	24.2	24.4
S.	6.4	6.6	6.8	7.0	7.2

Technology

Koroyd® Triax Fiberglass Size 149 : 5,6 lbs / 2,6 kg
Bcomp Carbon Flax Stringer Sintered 8000 Base
Boost Core Premium Eco Topsheet

Women's Twin Sister

The definitive do-it-all snowboard

All-mountain twin, easy-to-turn, versatile
Ideal for sending side hits, slashing pow and shredding groomers



The Women's Twin Sister is an award-winning directional twin built for riders who want a versatile board that balances power and play, from carving groomers to slashing side hits and exploring the whole mountain.

- Medium flex for confident control
- Directional twin shape for all-terrain riding
- CamRock profile for float and pop

Terrain



Shape Tech

Shape	Profile	Personality/Flex
Directional Twin	CamRock	Happy medium - 3/5

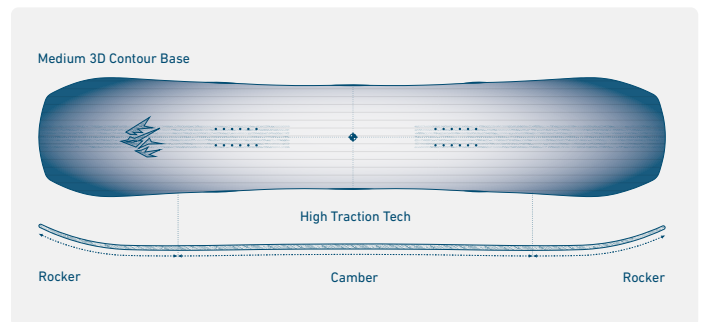

SIZE	140	143	146	149	152	155
W.W.	23.8	24.0	24.2	24.4	24.6	24.8
S.	6.6	6.8	7.0	7.2	7.4	7.6

Technology

Bcomp Carbon Flax Stringer Sintered 8000 Base Size 149 : 5,3 lbs / 2,4 kg
Master Core Premium Topsheet
Biax Fiberglass Freeride/Freestyle Pack

Women's Rally Cat

The all-mountain fun seeker

Friendly cruiser, easy-to-turn, playful

Ideal for all-terrain shredding and playful freestyle

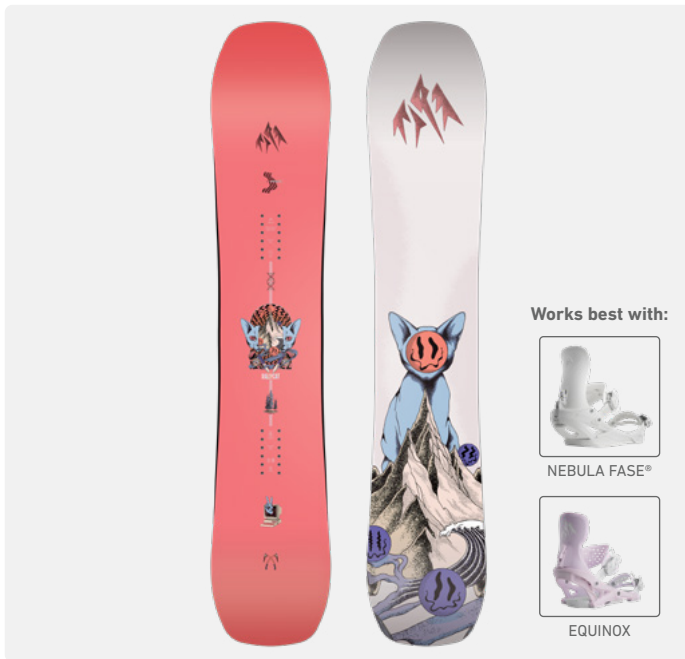

The Women's Rally Cat is a rider-favorite directional twin that delivers smooth, responsive performance, making every turn, carve, and pow slash feel effortless across the mountain.

- Friendly flex for fun loving board feel
- Directional twin shape for all-terrain
- Full camber profile for edge power

Terrain



Shape Tech

Shape	Profile	Personality/Flex
Directional Twin	True Camber	Friendly & playful - 2/5

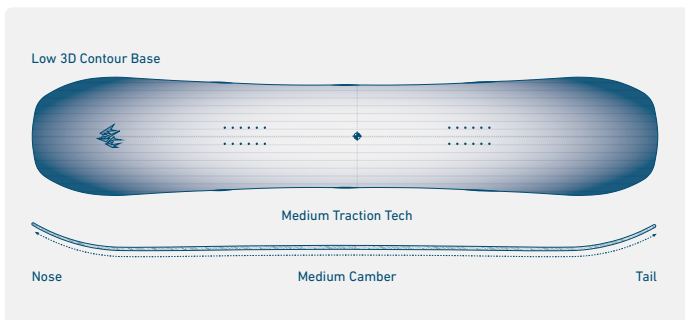

SIZE	139	142	145	148	151	154
W.W.	23.6	23.8	24.0	24.2	24.4	24.6
S.	6.0	6.2	6.4	6.6	6.8	7.0

Technology

Master Core	Premium Topsheet
Biax Fiberglass	Size 148 : 4,9 lbs / 2,2 kg
Sintered 8000 Base	



FREESTYLE SPIRIT, ALL-MOUNTAIN SOUL

Women's All-Mountain Freestyle

True Twin shapes built for popping, pressing, spinning, slashing and creative riding across the whole mountain.

Women's Tweaker 2.0

The updated fun hoggin' freestyler

All-mountain freestyle, poppy, playful, full camber

Ideal for all-mountain freestyle, creative side hits, and flowy lines



The Women's Tweaker 2.0 is an all-mountain freestyle true twin featuring a full camber profile, built to pop ollies, slash side hits, toss tricks, and carve creative lines in any terrain.

- Friendly flex for fun loving board feel
- Updated true twin shape for freestyle and switch
- Full camber profile for edge power

Terrain



Shape Tech

Shape	Profile	Personality/Flex
True Twin	True Camber	Friendly & Playful - 2/5

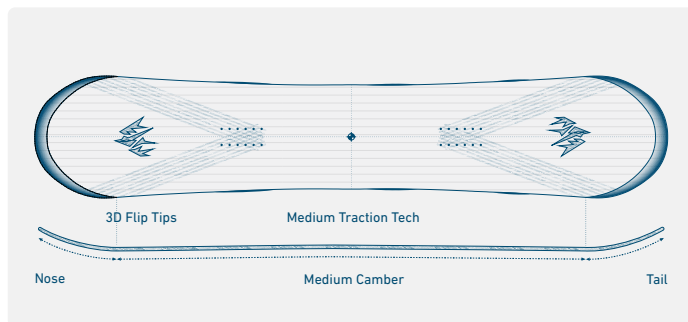

SIZE	140	143	146	149	151
W.W.	23.2	23.4	23.6	23.8	24.0
S.	6.0	6.2	6.4	6.6	7.0

Technology

Bcomp Carbon Flax Stringer	Sintered 8000 Base
Master Core	Premium Topsheet
Biax Fiberglass	Size 149 : 5,2 lbs / 2,3 kg



HIGH PERFORMANCE FOR KIDS

Youth Series

From first turns to freeride lines, the Youth Series covers every stage of progression with trusted Jones technologies.

Visual Line Plan

PRICE



CARRY OVER



CARRY OVER



Flagship Junior

Serious shred stick for smaller riders

All-conditions freeride, stable, floaty

Ideal for groomers, freeride, pow, slush or crust



The Flagship Junior is a high performance freeride board for youth and small adults who want to step up their skills and explore advanced terrain.

- Medium flex for confident control
- Tapered directional shape for nimble float
- Directional rocker profile for float and grip

Terrain



Shape Tech

Shape	Profile	Personality/Flex
Directional	Dir. Camber / Rocker	Mid-stiff & lively - 4/5

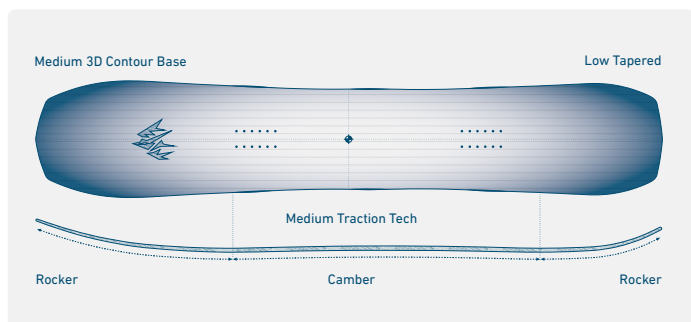

SIZE	127	132	137	142	147
W.W.	22.8	23.2	23.6	24.0	24.4
S.	6.0	6.3	6.6	6.9	7.2

Technology

Master Core
Biax Fiberglass
Sintered 8000 Base

Premium Topsheet
Size 137 : 4,4 lbs / 2 kg

Mountain Twin Junior

The definitive do-it-all snowboard

All-mountain twin, easy-to-turn, versatile

Ideal for growing skills, from first carves to all-mountain exploration

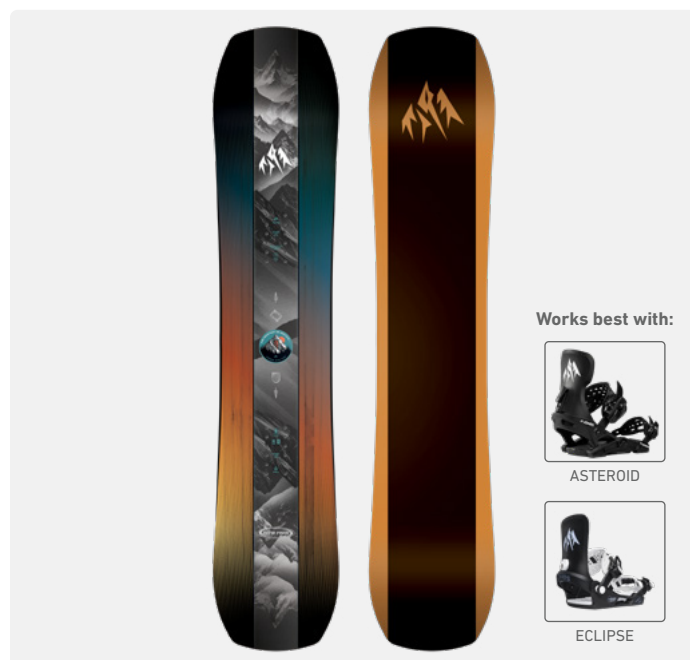

The Mountain Twin Junior is a directional twin made for youth riders who want to shred with confidence in any terrain and grow their bag of tricks.

- Medium flex for friendly control
- Directional twin shape for all-terrain
- CamRock profile for float and pop

Terrain



Shape Tech

Shape	Profile	Personality/Flex
Directional Twin	CamRock	Happy medium - 3/5

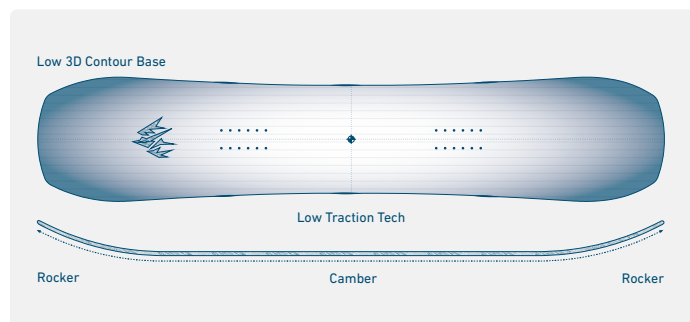

SIZE	120	125	130	135	140	145
W.W.	22.8	23.1	23.4	23.7	24	24.3
S.	5.5	5.8	6.1	6.4	6.7	7.0

Technology

Master Core
Biax Fiberglass
Extruded 5000 Base

Premium Topsheet
Size 135 : 4,2 lbs / 1,9 kg

Twin Sister Junior

The definitive do-it-all snowboard

All-mountain twin, easy-to-turn, versatile
Ideal for growing skills, from first carves to all-mountain exploration



The Twin Sister Junior is a directional twin made for youth riders who want to shred with confidence in any terrain and grow their bag of tricks.

- Medium flex for friendly control
- Directional twin shape for all-terrain
- CamRock profile for float and pop

Terrain



Shape Tech

Shape	Profile	Personality/Flex
Directional Twin	CamRock	Happy medium - 3/5

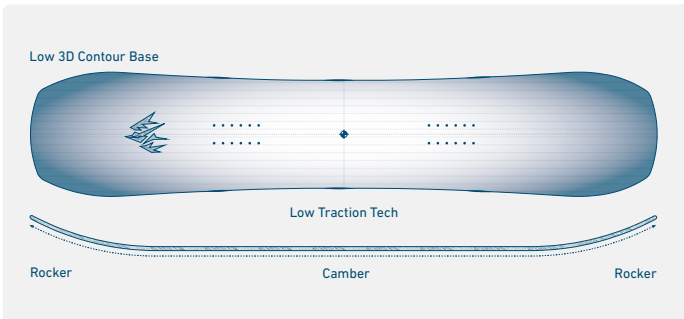

SIZE	120	125	130	135
W.W.	22.8	23.1	23.4	23.7
S.	5.5	5.8	6.1	6.4

Technology

Master Core
Biax Fiberglass
Extruded 5000 Base

Premium Topsheet
Size 125 : 3,7 lbs / 1,7 kg

Youth Prodigy

The first step to progression

All-mountain directional twin, easy-to-turn, versatile
Ideal for first turns, progression, and building all-mountain confidence



The Prodigy is an all-mountain directional twin built to make first turns easy, build confidence, and kickstart progression across the resort.

- Friendly flex for fun loving board feel
- Directional Twin shape for all-terrain
- CamRock profile for float and pop

Terrain



Shape Tech

Shape	Profile	Personality/Flex
Directional Twin	CamRock	Friendly & playful - 2/5

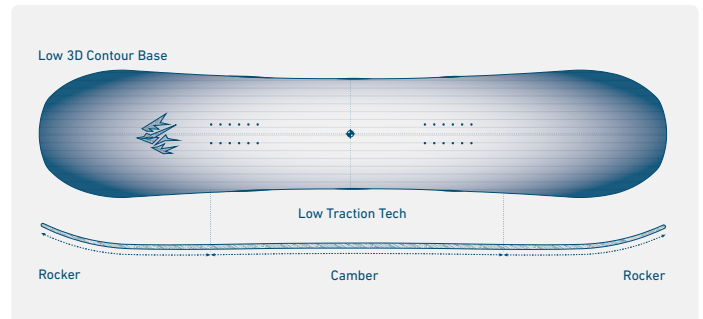

SIZE	80	90	100	110	115	120	125	130	135	140	145
W.W.	18	19	20.0	21.0	21.5	22.0	22.5	23.0	23.5	24.0	24.5
S.	3.3	4.1	5.1	5.4	5.5	5.7	5.9	6.0	6.2	6.3	6.5

Technology

Master Core
Biax Fiberglass
Extruded 5000 Base

Premium Topsheet
Size 130 : 4 lbs / 1,8 kg

Kids Prodigy Package

The first step to progression

All-mountain directional twin, easy-to-turn, versatile
Ideal for first turns, progression, and building all-mountain confidence

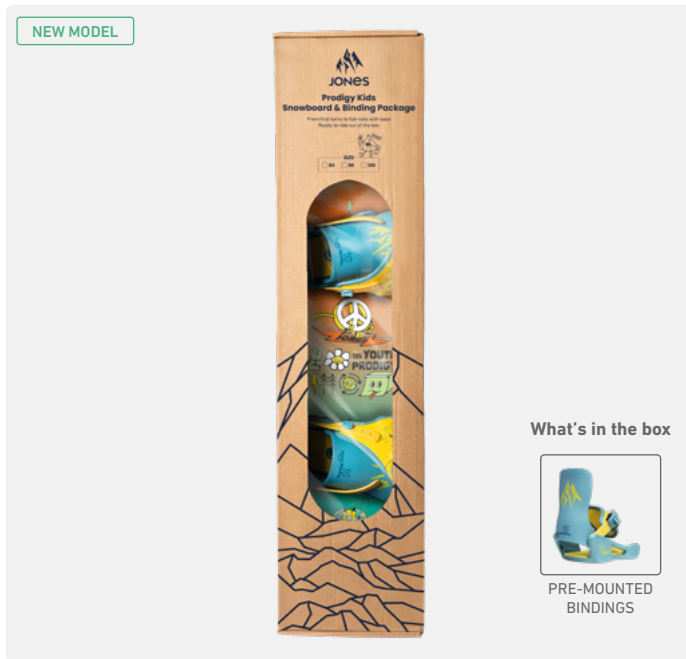

The Prodigy Pack is an all-mountain directional twin and binding built to make first turns easy, build confidence, and kickstart progression across the resort.

Kids Happy Mountain

First board for your young ripper

Learn-to-ride, stable, durable
Ideal for learning to balance and glide on a snowboard

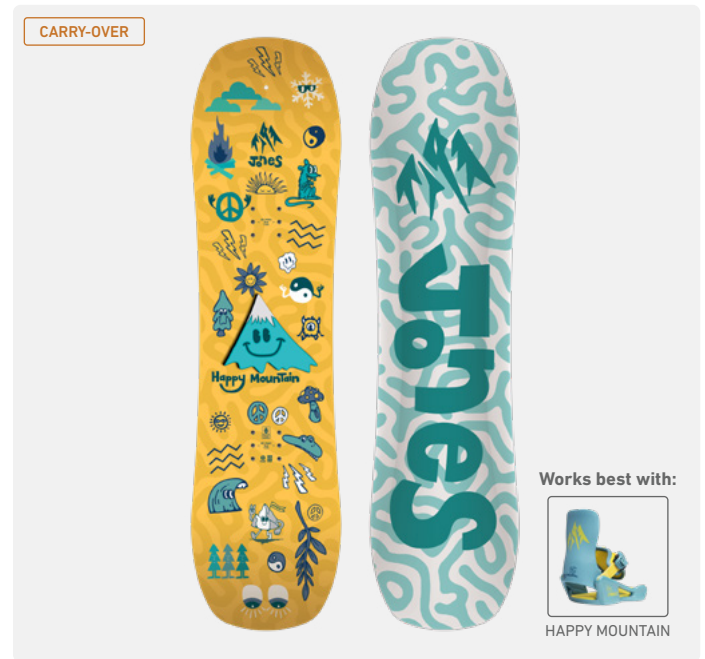

The Happy Mountain is a kids board featuring an innovative 3D Base made to get young rippers sliding and gliding with ease.

- 3D Base promotes balance and board control
- Concave center hull for stability and gliding straight
- Raised edges with angled side channels for smooth "no-catch" turn initiation

Terrain



Shape Tech

Shape	Profile	Personality/Flex
True Twin	FlatRock	Soft & playful - 1/5

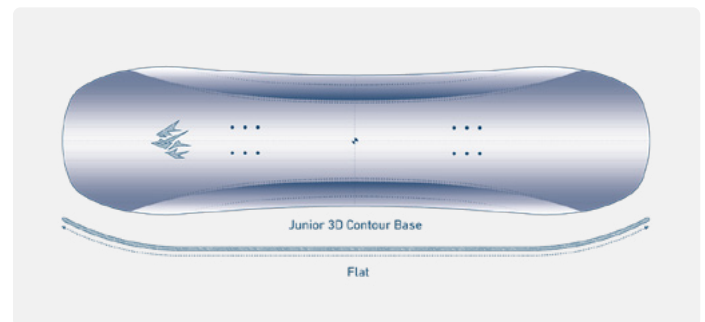

Technology

Biax Fiberglass	Size 90 : 1,9 lbs / 0,85 kg
Premium Topsheet	
Sintered 8000 Base	

Kids Happy Mountain Package

Strap in and go first snowboarding experience

Learn-to-ride, stable, durable
Ideal for learning to balance and glide on a snowboard

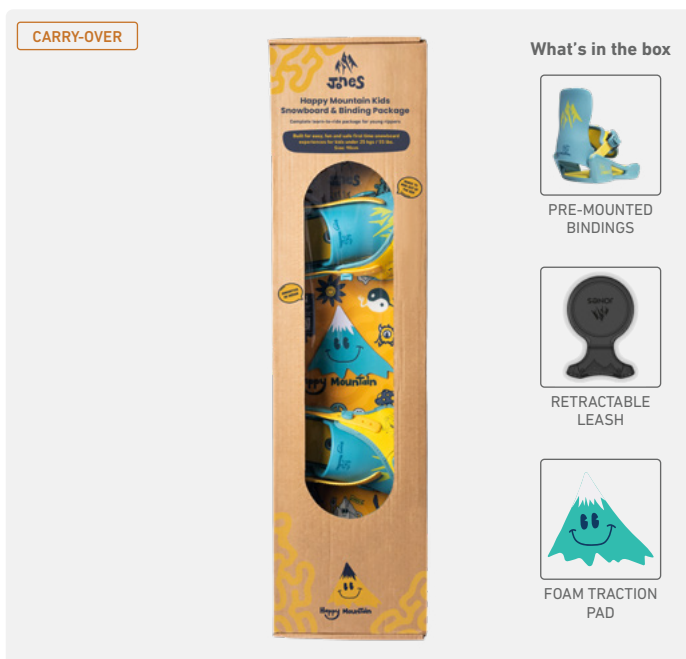



FREEDOM TOOLS

Splitboards

Backcountry splitboards engineered for efficient climbs and dynamic descents, built to take you deeper, further, and higher into every mountain range.

Visual Line Plan

PRICE ↑

Men's Howler Splitboard NEW MODEL



Women's Howler Splitboard NEW MODEL



Men's Stratos Splitboard CARRY OVER

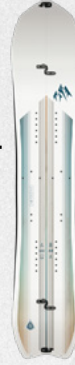

Women's Stratos Splitboard CARRY OVER



Men's Frontier 2.0 Splitboard



Women's Dream Weaver 2.0 Splitboard



Solution Junior Splitboard



Men's Solution Splitboard CARRY OVER



Women's Solution Splitboard CARRY OVER



Ultralight Solution Splitboard CARRY OVER



Ultralight Butterfly Splitboard CARRY OVER



Ultralight Hovercraft 2.0 Splitboard CARRY OVER



Hovercraft 2.0 Splitboard CARRY OVER



Storm Chaser Slipboard

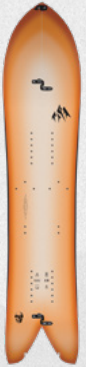

Ultralight Butterfly Splitboard

The ultralight, technical objective split

Lightweight, compact, stable, full camber

Ideal for high-alpine expeditions and technical backcountry touring



The Ultralight Butterfly Split is an ultralight splitboard made for high-alpine technical pursuits where the balance of weight and performance is critical.

- Fusion Carbon construction to reduce weight
- Compact shape with long effective edge
- Full camber profile for edge power

Terrain

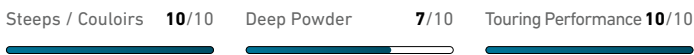

Shape Tech

Shape	Profile	Personality/Flex
Directional	True Camber	Mid-stiff & lively - 4/5

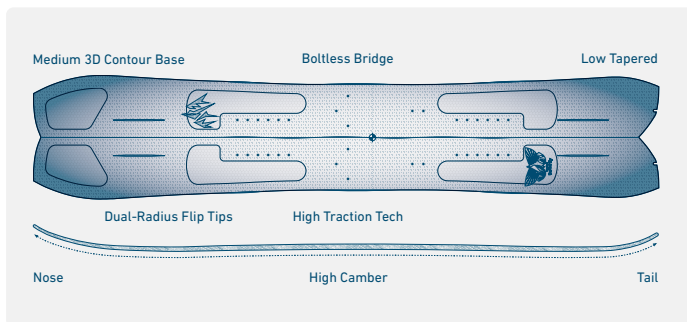

SIZE	150	154	158
W.W.	25.3	25.6	25.9
S.	8.5	8.8	9.1

Technology

Koroyd®	Karakoram Ultra Clips 3C	Karakoram Tip-Lock tip clips 2.0
Fusion Carbon	Ultra Base	Size 154 : 5,9 lbs / 2,7 kg
Fusion core	Ultralight Eco Topsheet	

Ultralight Hovercraft 2.0 Splitboard

The ultralight, all-conditions split

Long tours, lightweight, versatile, floaty

Ideal for expedition touring and high-alpine assaults

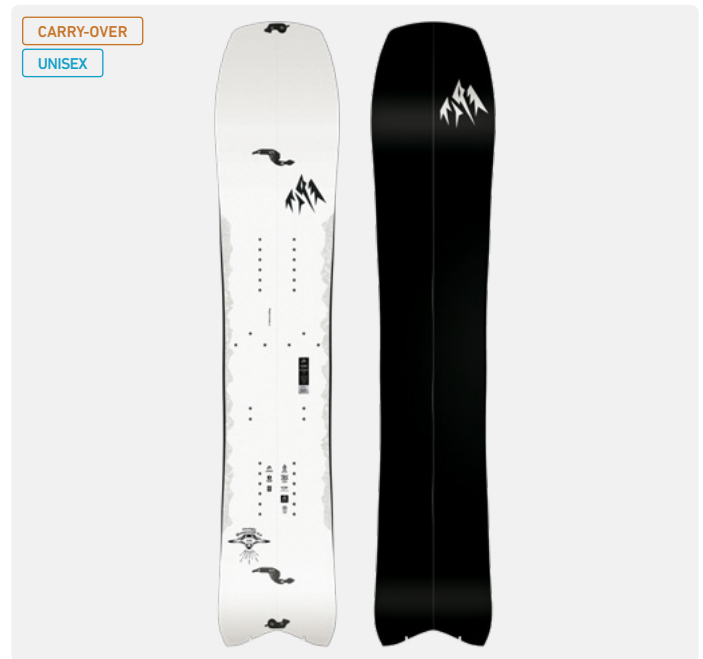

The Ultralight Hovercraft 2.0 Split is one of the lightest and most technically capable splitboards on the planet, featuring a nimble and versatile shape.

- Fusion Carbon construction to reduce weight
- Mid-stiff flex and tapered shape for pop and float
- Directional rocker profile for power and grip

Terrain

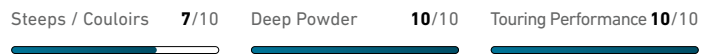

Shape Tech

Shape	Profile	Personality/Flex
Directional	Dir. Camber / Rocker	Mid-stiff & lively - 4/5

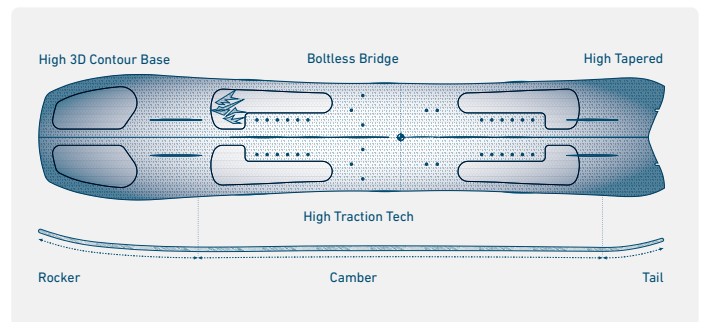

SIZE	152	156	160
W.W.	25.9	26.3	26.7
S.	8.7	9.0	9.3

Technology

Koroyd®	Karakoram Ultra Clips 3C	Karakoram Tip-Lock tip clips 2.0
Fusion Carbon	Ultra Base	Size 156 : 5,9 lbs / 2,7 kg
Fusion core	Ultralight Eco Topsheet	

Men's Ultralight Solution Splitboard

The backcountry line bomber

Lightweight, powerful, stable, for experts
Ideal for technical backcountry lines

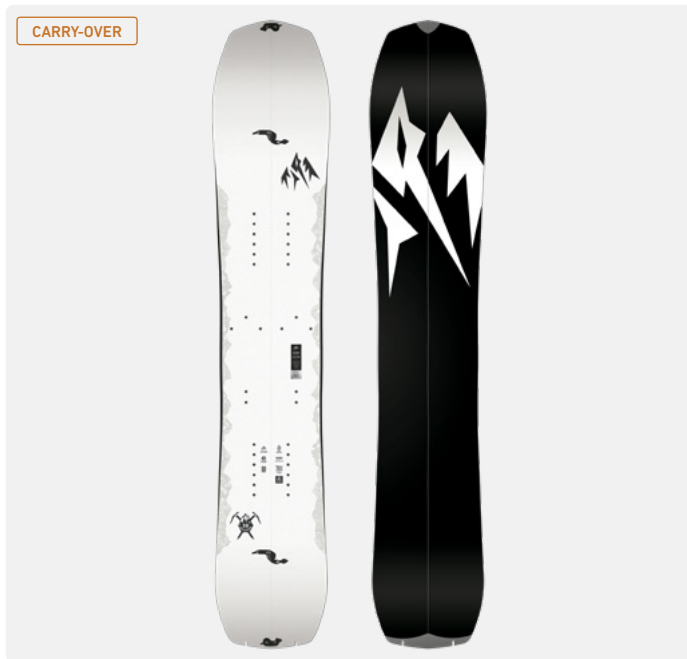

The Ultralight Solution is built for expert splitboarders who like to throttle turns at top speed and push the limits of what is possible in the backcountry.

- Fusion Carbon construction to reduce weight
- Stiff flex for power and response
- Directional rocker profile for power and grip

Terrain

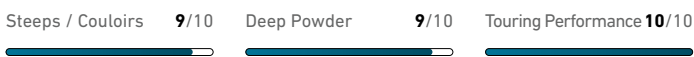

Shape Tech

Shape	Profile	Personality/Flex
Directional	Dir. Camber / Rocker	Stiff & Powerful - 5/5

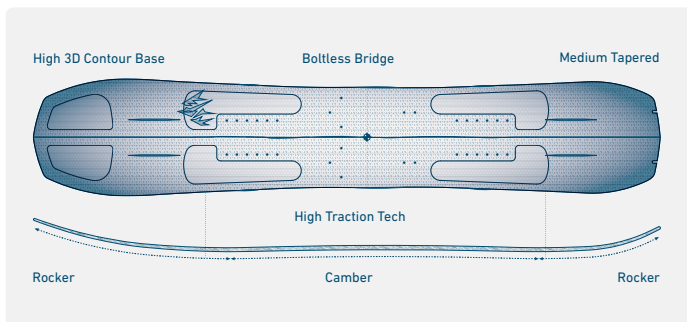

SIZE	158	161	162W	164	165W
W.W.	24.9	25.2	26.3	25.4	26.6
S.	8.5	9.1	9.3	9.3	9.4

Technology

Koroyd®	Karakoram Ultra Clips 3C	Karakoram Tip-Lock tip clips 2.0
Fusion Carbon	Ultra Base	Size 158 : 6 lbs / 2,7 kg
Fusion core	Ultralight Eco Topsheet	

Men's Solution Splitboard

The ultimate, all-conditions split

All-conditions all-terrain, stable, floaty
Ideal for backcountry freeriding and wilderness exploration

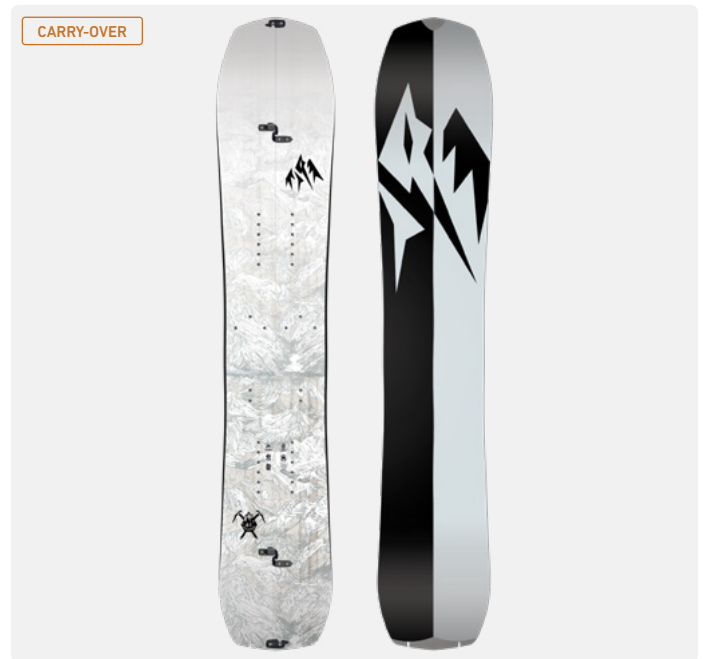

The Solution is the ultimate all-terrain splitboard and delivers unrivaled backcountry performance in any terrain or snow conditions.

- Mid-stiff flex and tapered shape for pop and float
- Directional rocker profile for power and grip
- Long sidecut for stability at speed

Terrain

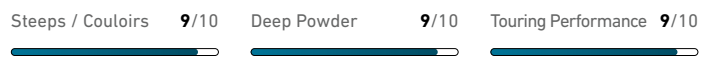

Shape Tech

Shape	Profile	Personality/Flex
Directional	Dir. Camber / Rocker	Mid-stiff & lively - 4/5

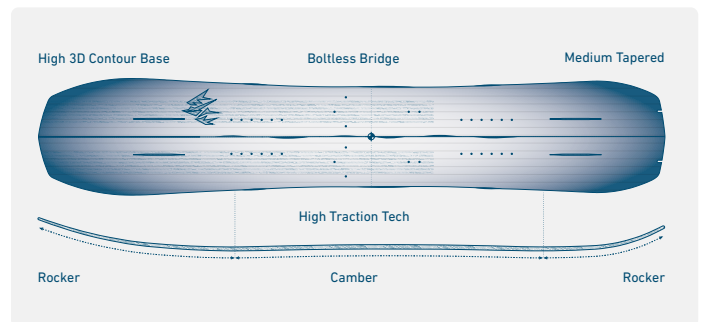

SIZE	154	158	159W	161	162W	164	165W	167	169W
W.W.	24.6	24.9	26.3	25.2	26.3	25.4	26.6	25.9	27.0
S.	7.9	8.5	8.7	9.1	9.3	9.3	9.4	9.4	9.5

Technology

Bcomp Carbon Flax Stringer	Sintered 9900 Base	Karakoram Ultra Clips 2.0
Ultra Split Core	Flip-Flop Base	Karakoram Tip-Lock tip clips 2.0
Triax Fiberglass	Textured Eco Topsheet	Size 158 : 6,8 lbs / 3,1 kg

Men's Howler Splitboard

The backcountry split for creative freeriders

Freeride x Freestyle, full camber, stable, poppy

Ideal for technical backcountry freeriding and freestyle

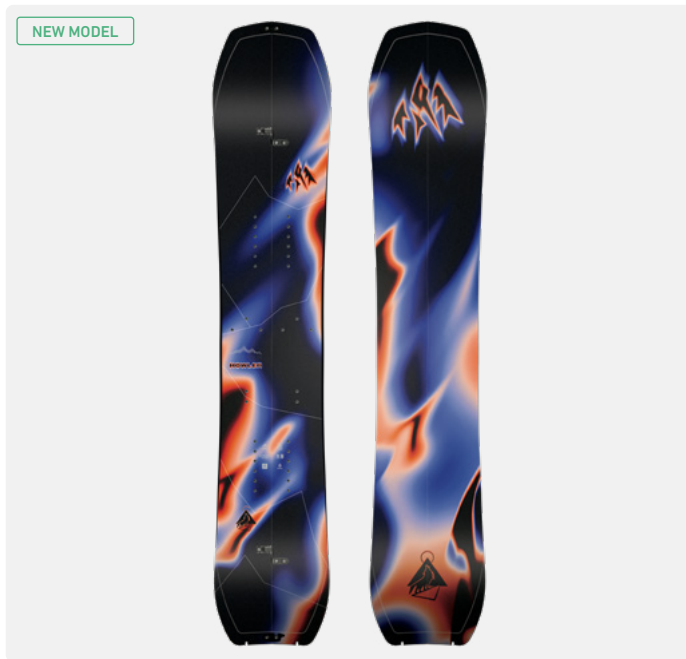

The Howler Split is a directional splitboard based on Victor de Le Rue's best-selling design, for full-throttle backcountry freeride x freestyle.

- Mid-stiff flex for power and control
- Tapered directional shape and 3D Flip Tips for nimble float
- High full camber profile for improved grip and trick stomping

Terrain

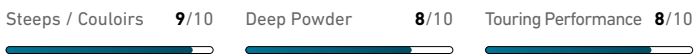

Shape Tech

Shape	Profile	Personality/Flex
Directional	High Power Camber	Mid-stiff & lively - 4/5

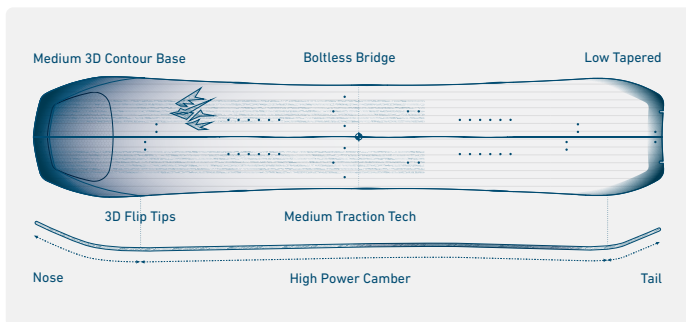

SIZE	158	160W	161
W.W.	25.7	26.7	26
S.	8.4	8.6	8.6

Technology

Koroyd®	Triax Fiberglass	Karakoram Ultra Clips 2.0 UPDATED
Bcomp Carbon Flax Stringer	Sintered 8000 Base	Size 155 : 5,9 lbs / 2,7 kg
Control Core Split	Premium Topsheet	

Men's Stratos Splitboard

The energetic, all-conditions split

All-conditions freeride, versatile, poppy

Ideal for all-terrain touring and dynamic freeriding

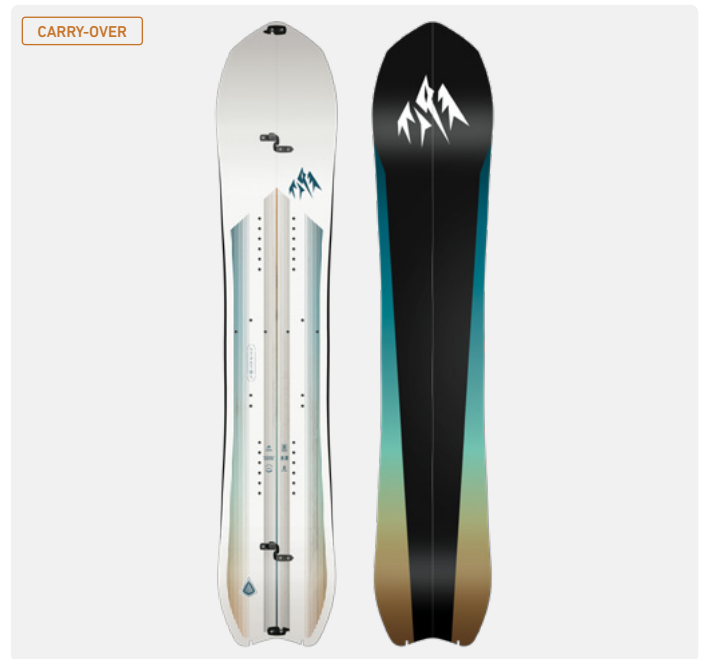

The Stratos Split is an all-conditions, all-terrain splitboard built for ripping turns, slashing gullies and boosting airs in the backcountry.

- Medium flex and tapered shape for nimble float
- Directional rocker profile for power and grip
- Short sidecut for nimble slashing

Terrain

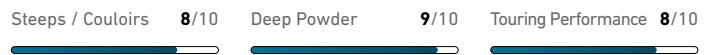

Shape Tech

Shape	Profile	Personality/Flex
Directional	Dir. Camber / Rocker	Happy medium - 3/5

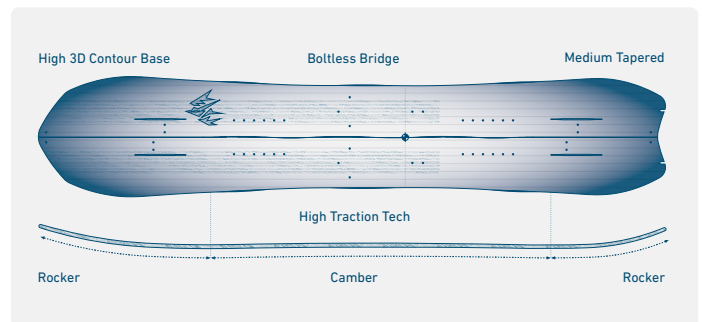

SIZE	156	158W	159	161W
W.W.	25.4	26.3	25.6	26.4
S.	7.2	7.4	7.5	7.7

Technology

Bcomp Carbon Flax Stringer	Sintered 8000 Base	Karakoram Ultra Clips 2.0
Biax Fiberglass	Flip-Flop Base	Karakoram Tip-Lock tip clips 2.0
	Textured Eco Topsheet	Size 156 : 6,8 lbs / 3,1 kg

Storm Chaser Splitboard

The backcountry surf slasher

Deep pow chaser, nimble, floaty

Ideal for surfing frozen waves and snorkel deep days



The Storm Chaser Splitboard unlocks access to those remote frozen swells and packs insane float into a short, but still high volume board.

- High volume shape for max float
- Surf Rocker profile for pow performance
- Short sidecut for nimble slashing

Terrain

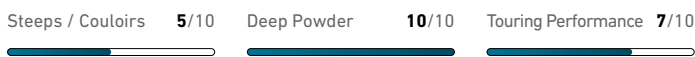

Shape Tech

Shape	Profile	Personality/Flex
Directional	Dir. Camber / Rocker	Happy medium - 3/5

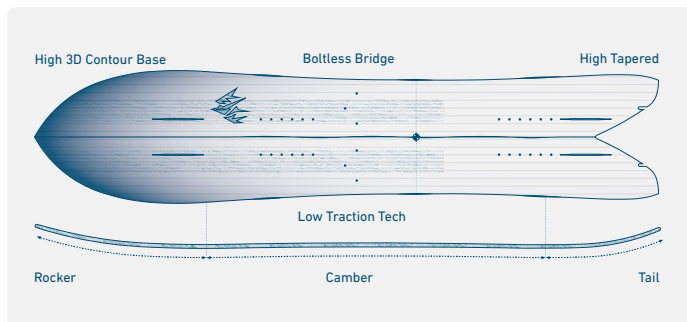

SIZE	152
W.W.	27.5
S.	6.9

Technology

- Control Split Core
- Biax Fiberglass
- Sintered 8000 Base
- Premium Topsheet
- Karakoram Ultra Clips 2.0
- Karakoram Tip-Lock tip clips 2.0

Hovercraft 2.0 Splitboard

The evolved backcountry racer

All-conditions touring, nimble, versatile

Ideal for backcountry chutes, bowls and tree runs

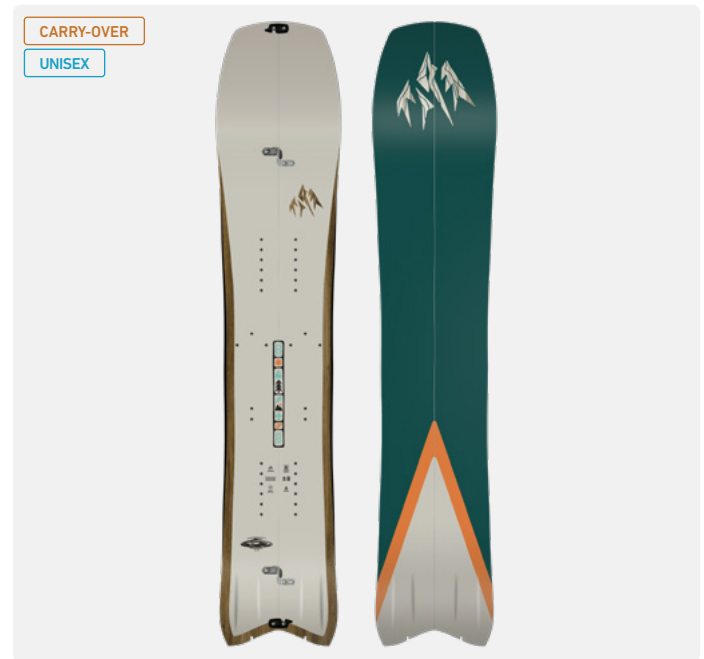

The Hovercraft 2.0 Split is a nimble and versatile all-terrain splitboard built with our most advanced 3D shaping technology and cutting-edge recycled materials.

- Medium flex and tapered shape for nimble float
- Directional rocker profile for power and grip
- Long sidecut for stability at speed

Terrain

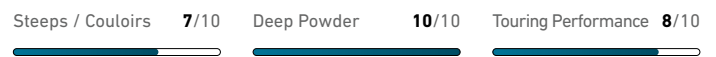

Shape Tech

Shape	Profile	Personality/Flex
Directional	Dir. Camber / Rocker	Happy medium - 3/5

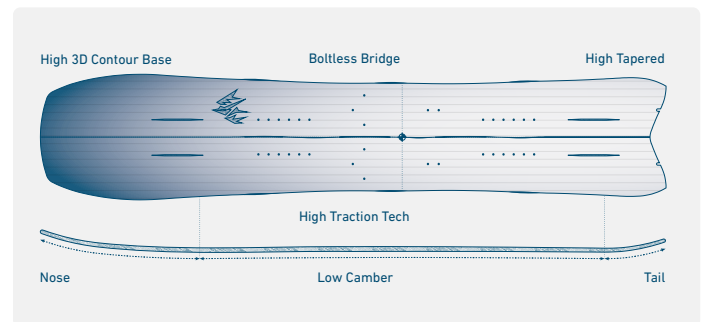

SIZE	148	152	156	160
W.W.	25.5	25.9	26.3	26.7
S.	8.4	8.7	9.0	9.3

Technology

- Control Split Core
- Biax Fiberglass
- Sintered 8000 Base
- Bcomp Carbon Flex Stringer **UPDATED**
- Size 152 : 6,8 lbs / 3,1 kg
- Control Split Core
- Biax Fiberglass
- Sintered 8000 Base
- Flax Fiber **UPDATED**
- Karakoram Ultra Clips 1.0
- Karakoram tip clips
- Size 156 : 6,7 lbs / 3,1 kg

Men's Frontier 2.0 Splitboard

The all-terrain, shred everything split

Friendly freeride, easy to turn, floaty

Ideal for freeride, mountain surfing and backcountry pow

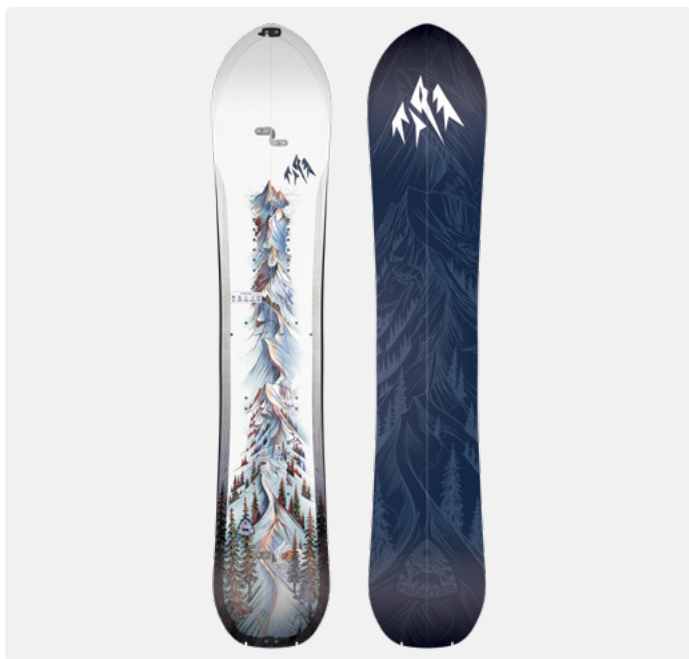

The Frontier 2.0 Split is an all-terrain, shred anything board with a tapered directional shape and a friendly flex that charges in all-conditions.

- Friendly flex and tapered shape for easy float
- Directional rocker profile with 3D Flip Tip for enhanced float and grip
- Short sidecut for nimble slashing

Terrain

Steps / Couloirs **7/10** Deep Powder **9/10** Touring Performance **8/10**

Shape Tech

Shape Directional **Profile** Dir. Camber / Rocker **Personality/Flex** Friendly & playful - 2/5

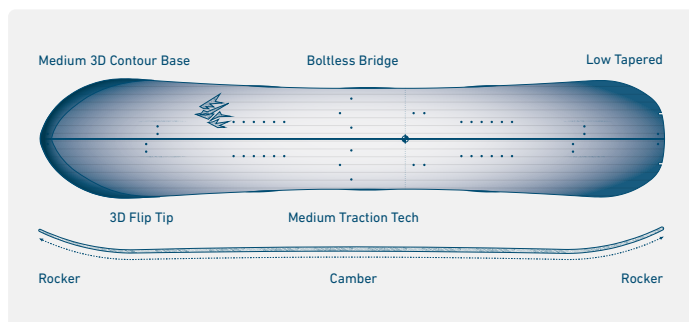

SIZE	156	158W	159	161W	162	164W
W.W.	25,2	26,5	25,5	26,7	25,8	26,9
S.	7,6	7,8	7,8	8,0	8,0	8,2

Technology

Control Split Core Premium Eco Topsheet Size 156 : 6,7 lbs / 3,1 kg
 Biax Fiberglass Karakoram Ultra Clips 2.0 UPDATED
 Sintered 8000 Base Karakoram tip clips

Women's Solution Splitboard

The ultimate women's split

All-conditions performance, stable, floaty

Ideal for backcountry freeriding and wilderness exploration

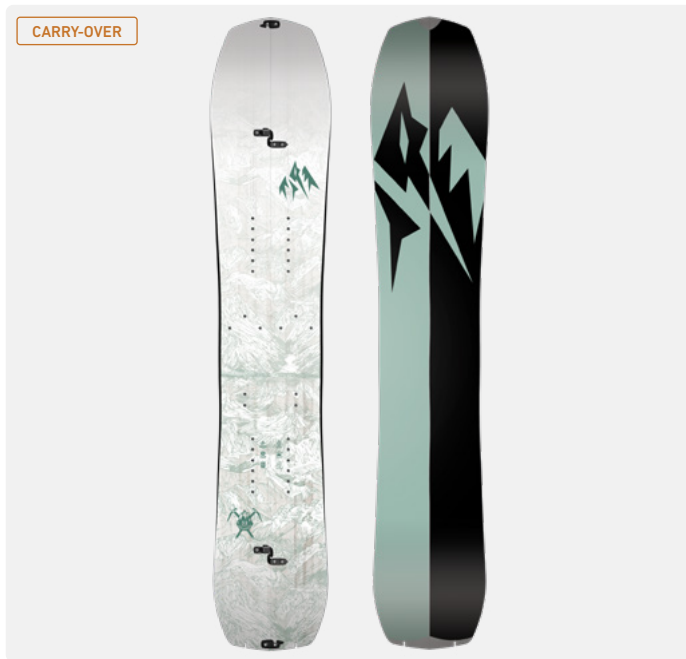

The Women's Solution is the ultimate all-terrain splitboard and delivers unrivaled backcountry performance in any terrain or snow conditions.

- Mid-stiff flex and tapered shape for pop and float
- Directional rocker profile for power and grip
- Long sidecut for stability at speed

Terrain

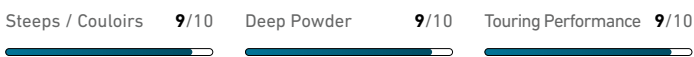

Shape Tech

Shape	Profile	Personality/Flex
Directional	Dir. Camber / Rocker	Mid-stiff & lively - 4/5

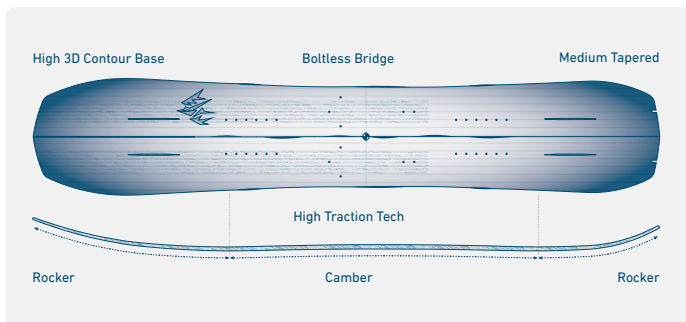

SIZE	146	149	152	155
W.W.	23.7	23.9	24.1	24.3
S.	7.1	7.3	7.5	7.8

Technology

Bcomp Carbon Flax Stringer	Sintered 8000 Base	Karakoram Ultra Clips 2.0
Ultra Split Core	Flip-Flop Base	Karakoram Tip-Lock tip clips 2.0
Triax Fiberglass	Textured Eco Topsheet	Size 149 : 5,7 lbs / 2,6 kg

Women's Howler Splitboard

The backcountry split for creative freeriders

Freeride x Freestyle, full camber, stable, poppy

Ideal for technical backcountry freeriding and freestyle

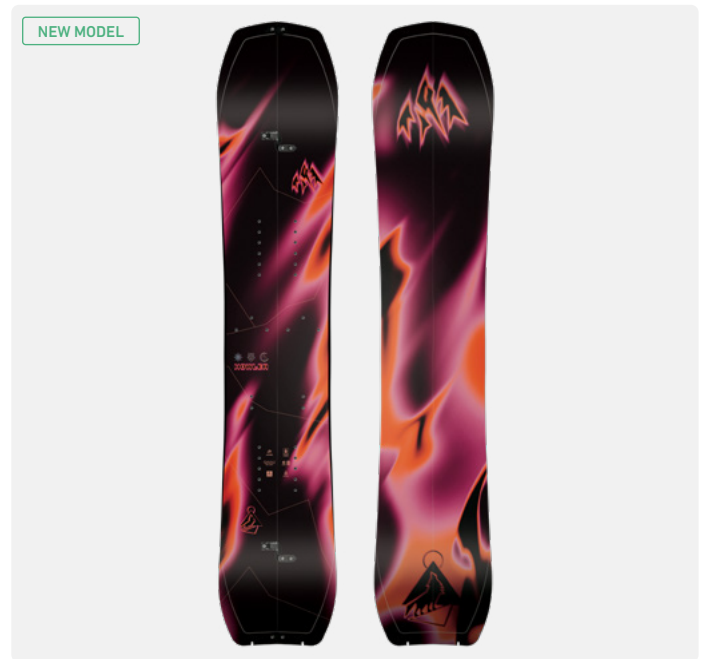

The Women's Howler Split is a directional splitboard based on Elena Hight's best-selling design, for full-throttle backcountry freeride x freestyle.

- Mid-stiff flex for power and control
- Tapered directional shape and 3D Flip Tips for nimble float
- High full camber profile for improved grip and trick stomping

Terrain

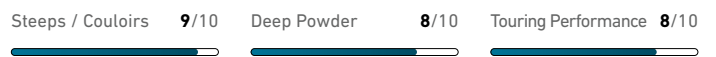

Shape Tech

Shape	Profile	Personality/Flex
Directional	High Power Camber	Mid-stiff & lively - 4/5

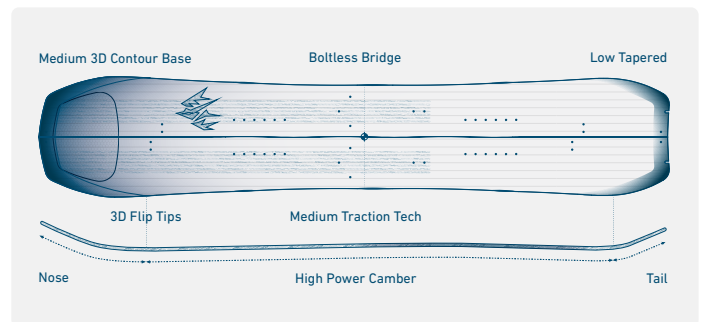

SIZE	148	151
W.W.	24.5	24.7
S.	7.6	7.8

Technology

Koroyd®	Triax Fiberglass	Karakoram Ultra Clips 2.0
Bcomp Carbon Flax Stringer	Sintered 8000 Base	Karakoram Tip-Lock tip clips 2.0
Control Split Core	Premium Topsheet	Size 148 : 5,3 lbs / 2,4 kg

Women's Stratos Splitboard

The energetic, all-conditions split

All-conditions freeride, versatile, poppy
Ideal for all-terrain touring and dynamic freeriding

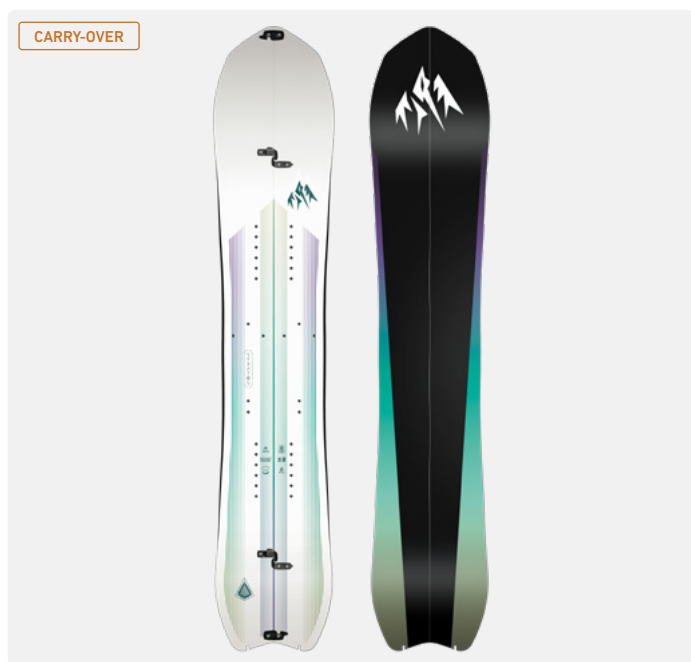

The Women's Stratos Split is an all-conditions, all-terrain splitboard built for ripping turns, slashing gullies and boosting airs in the backcountry.

- Medium flex and tapered shape for nimble float
- Directional rocker profile for power and grip
- Short sidecut for nimble slashing

Terrain



Shape Tech

Shape	Profile	Personality/Flex
Directional	Dir. Camber / Rocker	Happy medium - 3/5

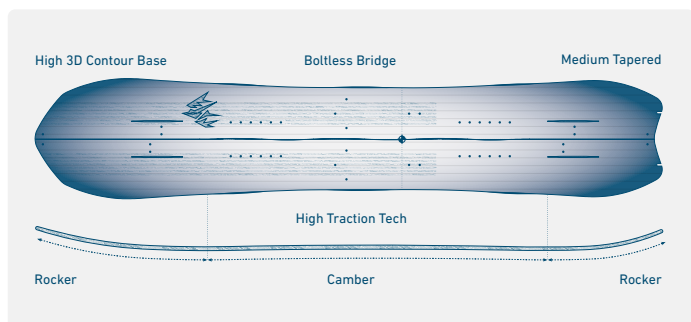

SIZE	146	149	152
W.W.	23.9	24.2	24.4
S.	6.3	6.5	6.7

Technology

Bcomp Carbon Flax Stringer	Sintered 8000 Base	Karakoram Ultra Clips 2.0
Ultra Split Core	Flip-Flop Base	Karakoram Tip-Lock tip clips 2.0
Biax Fiberglass	Textured Eco Topsheet	Size 149 : 5,9 lbs / 2,7 kg

Women's Dream Weaver 2.0 Splitboard

The playful backcountry charger

Friendly freeride, easy to turn, floaty
Ideal for backcountry touring in all-conditions

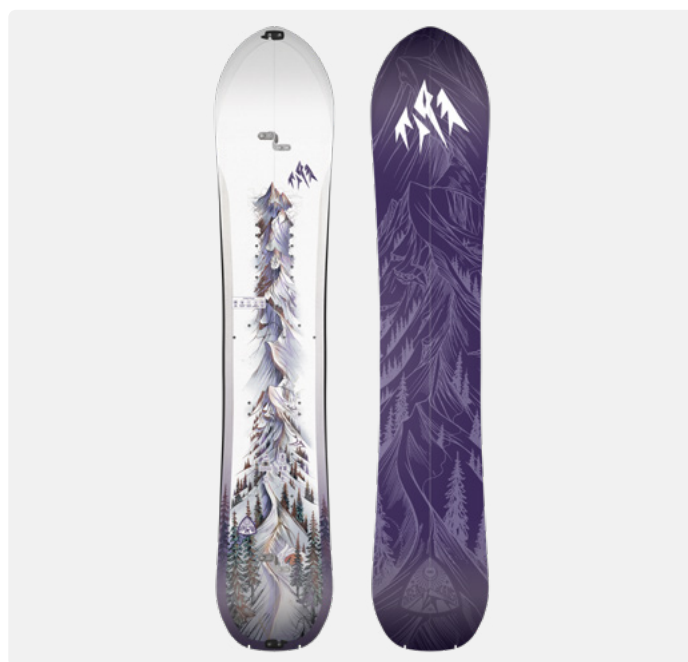

The Dream Weaver 2.0 Split is a high performance split with a tapered directional shape and a friendly flex that rips in all-conditions.

- Friendly flex + tapered shape for easy float
- Directional rocker profile with 3D Flip Tips for enhanced float and grip
- Short sidecut for nimble slashing

Terrain



Shape Tech

Shape	Profile	Personality/Flex
Directional	Dir. Camber / Rocker	Friendly & playful - 2/5

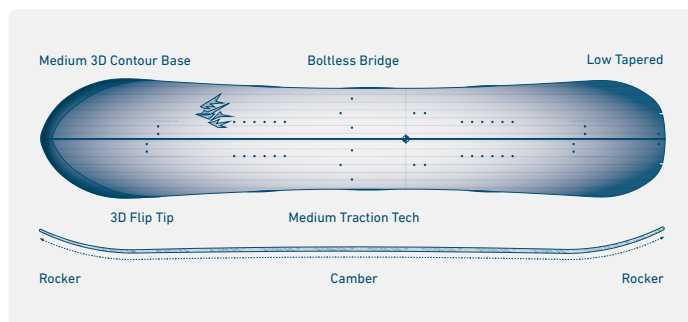

SIZE	145	148	151	154
W.W.	23.9	24.1	24.3	24.5
S.	6.9	7.1	7.3	7.5

Technology

Control Split Core	Premium Eco Topsheet	Size 148 : 6 lbs / 2,7 kg
Biax Fiberglass	Karakoram Ultra Clips 1.0	
Sintered 8000 Base	Karakoram tip clips	

Solution Junior Splitboard

Serious backcountry tool for smaller riders

All-conditions performance, stable, floaty

Ideal for sidecountry and backcountry exploration



The Solution Junior is a high performance splitboard designed to allow youth and small adults to confidently ride advanced backcountry terrain.

- Medium flex for confident control
- Tapered directional shape for nimble float
- Directional rocker profile for float and grip

Terrain

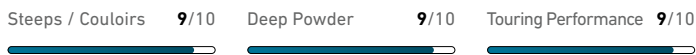

Shape Tech

Shape	Profile	Personality/Flex
Directional	Dir. Camber / Rocker	Mid-stiff & lively - 4/5

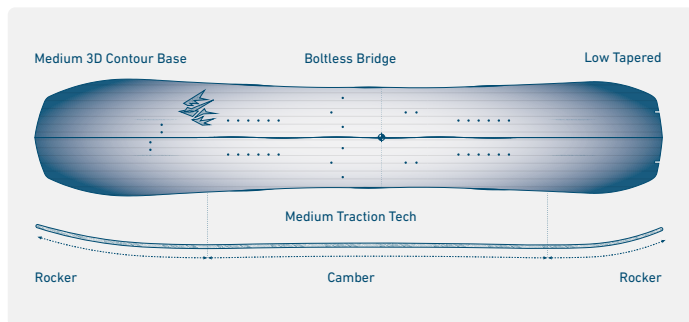

SIZE	137	142	147
W.W.	23.6	24.0	24.4
S.	6.6	6.9	7.2

Technology

Control Split Core	Flip-Flop Base	Karakoram tip clips
Biax Fiberglass	Premium Topsheet	Size 137 : 4,8 lbs / 2,2 kg
Sintered 8000 Base	Karakoram Ultra Clips 1.0	



ADVANCED ASCENT GEAR, BUILT TO LAST

Splitboard Skins

Our splitboard skins are designed for ultimate performance, durability and functionality.

Nomad Pro

The ultimate splitboard skin

Ideal for all-seasons, all-conditions backcountry touring



Nomad Pro Skins are the ultimate high performance splitboard climbing skin and offer unmatched performance in any snow condition.

- 70% mohair / 30% synthetic for glide + grip
- Rubber backing to help keep skins dry
- Ever Dry 3.0 treatment for wet snow
- Treated with Glide Tech for extra glide
- 9 pre-cut sizes. No trimming needed.
- Fits any 2016 or newer Jones splitboards

Quick Tension Tail Clip

Pre-cut by size:

Pre-cut skin/ 9 pre-cut sizes
Fits all 2016 splits and newer

Trim-to-fit by size:

Trim-to-fit skins (S/M/L)
Fits all 2016 splits and newer

Universal Tail Clip

Trim-to-fit universal:

Trim-to-fit skin
Skin size: 140x1450 mm
Fits all splitboard brands

Skins technology

Glide Tech
Rubber Safer skins
Ever Dry
Grip Tech

70% mohair & 30% nylon
Universal tip clip
PFC-Free skins
Made without PFAS

Skins package includes

Quick tension tail clip:

One pair skins with Quick Tension Tail Clips attached / Two backing sheets / Skin bag / Skin saver

Universal tail clip:

One pair skins / One pair universal tail clips / Four rivets / Two backing sheets / Skin cutter / Skin bag / Skin saver

Nomad

The classic splitboard skin

Ideal for backcountry touring and wilderness exploration



Nomad Skins offer the perfect balance of glide and grip and are ideal for backcountry touring and wilderness exploration.

- 70% mohair / 30% synthetic for glide + grip
- Rubber backing to help keep skins dry
- Ever Dry 3.0 treatment for wet snow
- 9 pre-cut sizes. No trimming needed.
- Fits any 2016 or newer Jones splitboards

Quick Tension Tail Clip

Pre-cut by size:

Pre-cut skin/ 9 pre-cut sizes
Fits all 2016 splits and newer

Trim-to-fit by size:

Trim-to-fit skins (S/M/L)
Fits all 2016 splits and newer

Universal Tail Clip

Trim-to-fit universal:

Trim-to-fit skin
Skin size: 140x1450 mm
Fits all splitboard brands

Skins technology

Rubber Safer skins
Ever Dry
Grip Tech
70% mohair & 30% nylon

Universal tip clip
PFC-Free skins
Made without PFAS

Skins package includes

Quick tension tail clip:

One pair skins with Quick Tension Tail Clips attached / Two backing sheets / Skin bag / Skin saver

Universal tail clip:

One pair skins / One pair universal tail clips / Four rivets / Two backing sheets / Skin cutter / Skin bag / Skin saver

Skin group size chart

Skin group	2027 Board Models
A	Women's Dream Weaver 2.0 Splitboard 145, 148, 151, 154
	Women's Solution Splitboard 146, 149, 152, 155
	Solution Splitboard Junior 147
	Women's Stratos Splitboard 146, 149, 152
	Women's Howler Splitboard 148, 151 NEW
B	Men's Solution Splitboard 154, 158, 161
	Men's Ultralight Solution Splitboard 158, 161
	Men's Frontier 2.0 Splitboard 156, 159, 162
C	Hovercraft 2.0 Splitboard 148, 152, 156
	Men's Stratos Splitboard 156
	Ultralight Butterfly Splitboard 158
	Ultralight Hovercraft 2.0 Splitboard 152, 156
D	Men's Solution Splitboard 164
	Men's Stratos Splitboard 159
	Men's Ultralight Solution Splitboard 164
	Men's Howler Splitboard 158, 161 NEW
	Ultralight Butterfly Splitboard 150, 154

Skin group	2027 Board Models
E	Hovercraft 2.0 Splitboard 160
	Men's Solution Splitboard 165W
	Men's Ultralight Solution Splitboard 165W
	Ultralight Hovercraft 2.0 Splitboard 160
F	Men's Solution Splitboard 162W, 167
	Men's Ultralight Solution Splitboard 162W
G	Men's Frontier 2.0 Splitboard 158W, 161W, 164W
	Men's Solution Splitboard 159W
	Men's Stratos Splitboard 158W, 161W
H	Men's Howler Splitboard 160W NEW
	Men's Solution Splitboard 169W
i	Storm Chaser Splitboard 152
Trim-to-fit by size - S	Solution Junior Splitboard 137, 142

Sizes in green = Best skin group has been updated, but board remains compatible with previously selected group.

Skin technology



Made in Switzerland

Jones skins are made in Switzerland by one of the most innovative and trusted skin manufacturers in the world, POMOCA. For the last 40 years POMOCA has produced industry leading skins for high altitude ski mountaineering and randonnee racing.

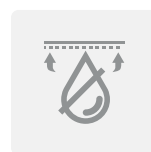

Rubber safer skins

Jones skins are laminated with a rubber backing that prevents skins from getting waterlogged. Drier skins are safer as they are less likely to lose adhesion to your skis in critical situations.



Glide tech

Glide Tech coating reduces friction on each skin fiber so neither super-cold fresh snow or wet, hot snow will stick to the skin and rob energy-saving glide.



70 % Mohair / 30% nylon

Jones Nomad and Nomad Pro climbing skins are both made with a blend of 70% mulesing free natural mohair fiber and 30% synthetic nylon. The mohair offers unmatched glide and a supple skin feel while the nylon improves grip and water repellency.



Grip tech

Grip Tech skins are made with a special material that works well under dynamic tension and has a high resistance to twisting and abrasion.

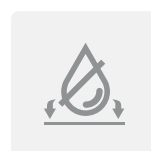

Ever dry (bluesign® approved)

Jones skins are treated with Ever Dry anti-glopping treatment. The coating keeps the skins from absorbing moisture and prevents snow/ice build-up under the skin.





EQUIPMENT FOR THE UNKNOWN

Outerwear

Environmentally minded and movement focused technical gear
built to embrace all of Mother Nature's moods.

WE BELIEVE THERE IS A BETTER WAY

Eco-Performance



We believe there is a better way. A better way to manufacture apparel so that it does less harm, and lasts longer. A better way to protect yourself from nature's wrath without sacrificing comfort, mobility and breathability. And a better way to get more versatility out of fewer pieces, to design clothing that adapts to nature's moods.

From upcycled down to body mapped recycled fabrics, Jones outerwear is about making cutting edge apparel that performs just like we move through the mountains – with complex simplicity. One foot in front of the other, but no wasted steps, and no wasted energy. This is apparel we believe in every step of the way.

When we set out to start making apparel, this is what drove us. To do things differently, and bring new winter apparel concepts to the world that blend comfort, performance and sustainability in a fresh look and fit. Every piece in the collection is purposefully designed to be extremely functional to help you unlock your wildest dreams in the mountains.



Fabrics made without PFAS

Starting with our 2025 collection, all of our outerwear and apparel fabrics are made without PFOA/PFAS and we use only PFC-Free DWR treatments. PFOA, PFAS and PFC are chemicals known to accumulate in the environment.



Socially responsible factories

All our outerwear and apparel production facilities are Business Social Compliance Initiative (BSCI) or Worldwide Responsible Accredited Production (WRAP) certified. These certifications guarantee that the people who make our apparel receive fair salaries and work in safe and clean working environments.



Oeko-Tex® and/or Bluesign® certified mills

All of our fabrics come from Oeko-Tex and/or bluesign certified mills. Oeko-Tex and bluesign textiles and fabrics are certified to be free of harmful chemicals and safe for human use.



Organic Cotton

We use only 100% organic cotton in our lifestyle apparel. Organic cotton uses less water and chemicals than conventionally grown cotton.



All of our outerwear and apparel is built using recycled fabrics

Most are 100% recycled. Using recycled fabrics helps keep waste out of the landfill and reduces the need for virgin materials.



Recycled Down

We only use ultra high performance 100% recycled 750 fill power down that is upcycled from sleeping bags and jackets. Recycled down keeps materials out of the landfill.

Ingredients

Built with the finest tech and materials.

Jones apparel is the future of environmentally minded, movement focused technical gear built for pushing limits and erasing boundaries. The 2026-27 collection balances unmatched performance and durability with industry leading sustainable manufacturing and material standards. Backed by our lifetime warranty.

MATERIALS

Softgoods



GORE-TEX 3L Performance ePE NEW

Made out of 100% recycled waterproof breathable three-layer laminate shell fabric that is PFAS-Free. Solid protection for extreme use that's "Guaranteed To Keep You Dry".

Products: Men's Higher GORE-TEX 3L Jacket & Bibs



GORE-TEX 2L ePE NEW

Made out of 100% recycled waterproof breathable two-layer laminate shell fabric that is PFAS-Free. Trusted comfort and protections that's "Guaranteed To Keep You Dry".

Products: Men's & Women's Deeper GORE-TEX Jackets & Pants

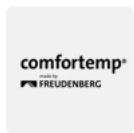

Freudenberg comfortemp® NEW

Sustainable and advanced Essential SCU xR insulation for warmth in cold temperatures, made from post-consumer plastic bottles.

Products: All Men's & Women's Deeper GORE-TEX Insulated Jackets and MTN Surf Insulated Jackets



Naia™ NEW

Sustainable, high-performance cellulose fiber, made from responsibly sourced pine and eucalyptus wood pulp. It delivers a luxurious feel when blended into our performance layering fabrics.

Products: Men's Shastarama Hooded Tech Tee and Men's L/S Tech Tee



RECCO

Outerwear integrated passive radar reflector that allows wearers to be searchable to rescue personnel equipped with a RECCO detector.

Products: Men's Higher GORE-TEX 3L Jacket & Bibs, Men's and Women's Further 3L Jacket & Pants

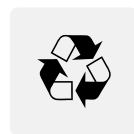

Recycled Fabrics

Stormproof, breathable and stretchy three-layer and two-layer laminate fabrics that are made without PFAS and are 100% recycled.

Products: All Men's & Women's Further and MTN Surf Outerwear



750-fill RENU Down

Ultra high performance 100% recycled 750-fill down insulation made by Allied Feather + Down.

Products: Unisex Max Re-Up Down 750+ Hooded Jacket, Men's Ultra Re-Up Down 750+ Jacket

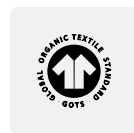

Global Organic Standard (GOTS) Certified

GOTS certified fabrics meet all internationally recognized environmental and socially responsible manufacturing standards for organic textiles.

Products: All tees & hoodies



Air Flake

Soft, high loft, super packable and quick drying 100% recycled synthetic insulation material that retains its warmth even when wet.

Products: Men's Dark Start Stretch Hooded Jacket



Organic Cotton

Organic cotton uses less water, plus creates less waste and CO₂ emissions compared to conventional cotton.

Products: All tees & hoodies, Fresh Corduroy Cap

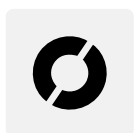

Polylana

Low-impact alternative to 100% acrylic fiber that requires less energy, water, waste and CO₂ emissions to produce.

Products: Anchorage, Tahoe, Kodiak, Chamonix & Baker Beanies



Repreve

Unique 100% recycled polyester certified to contain 80% post-consumer recycled content (plastic bottles) and 20% pre-consumer recycled content (factory material scraps).

Products: All neckwarmers & balaclavas, Paliwood Fleece Beanie



STORM-PROVEN, EXPEDITION-READY

Men's Higher GORE-TEX 3L

Engineered to endure the extremes, built to push boundaries.

Men's Higher GORE-TEX 3L Jacket



Storm ready, expedition proven

Ultimate protection, fully featured, durable
Ideal for alpine adventures in extreme conditions

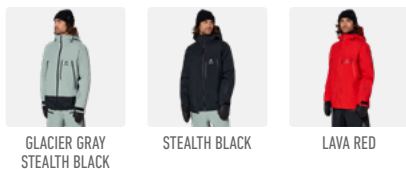

GLACIER GRAY
STEALTH BLACK

STEALTH BLACK

LAVA RED

The Higher GORE-TEX 3L Jacket is built for riding and climbing in extreme conditions. It offers unmatched performance and rugged all-conditions protection.

- Best for riding in extreme conditions and multi-day expeditions
- Updated GORE-TEX 3L Performance ePE recycled fabric for rugged, stormproof durability
- Regular fit with articulated cut for unrestricted movement

Performance



Materials



100% recycled 70D nylon GORE-TEX 3L Performance ePE shell fabric.
PFC-Free DWR.

Features



- | | | |
|------------------------------------|--------------------------|---------------------------------|
| Fully taped seams | Internal phone sleeve | Zippered internal chest pocket |
| Forearm pass pocket | Armpit vent zips | Adjustable hood with cord locks |
| Two zippered external hand pockets | Adjustable powder gaiter | Adjustable hem with cord locks |
| Two internal dump pockets | Helmet compatible hood | Velcro adjustable cuffs |
| | | Recycled zip pull cords |

Men's Higher GORE-TEX 3L Bibs



Storm ready, expedition proven

Ultimate protection, fully featured, durable
Ideal for alpine adventures in extreme conditions

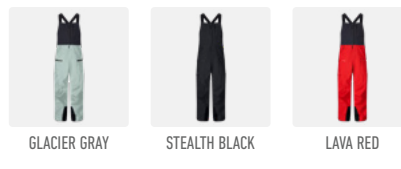

GLACIER GRAY

STEALTH BLACK

LAVA RED

The Higher GORE-TEX 3L Bibs are built for riding and climbing in extreme conditions. They offer unmatched performance and rugged all-conditions protection.

- Best for riding in extreme conditions and multi-day expeditions
- Updated GORE-TEX 3L Performance ePE recycled fabric for rugged, stormproof durability
- Regular fit with articulated cut for unrestricted movement

Performance

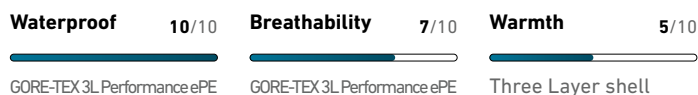

Materials



100% recycled 70D nylon GORE-TEX 3L Performance ePE shell fabric.
PFC-Free DWR.

Features



- | | | |
|--|---|----------------------------|
| Fully taped seams | Two zippered chest pockets | Articulated knee pattern |
| Chest dump pocket | Zippered side seam vents and quick relief drop seat | Adjustable shoulder straps |
| Two zippered thigh pockets with phone sleeve on right side | Durable powder gaiters | Double snap front closure |
| | Reinforced inner cuff fabric | Full frontal bib zip |
| | | Durable kick patch |

GUARANTEED PROTECTION IN ALL CONDITIONS

Men's Deeper GORE-TEX

Premium performance for the harshest conditions. Outerwear that delivers on every lap.



Men's Deeper GORE-TEX Insulated Jacket



All-conditions warmth, proven protection

Lightly insulated, comfortable, relaxed fit
Ideal for all-conditions resort and sidecountry adventures



Men's Deeper GORE-TEX Jacket



Proven protection in all conditions

Versatile, comfortable, relaxed fit
Ideal for all-conditions resort and sidecountry adventures

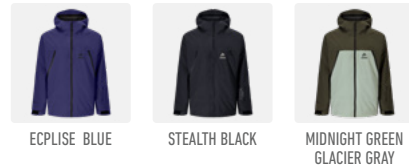
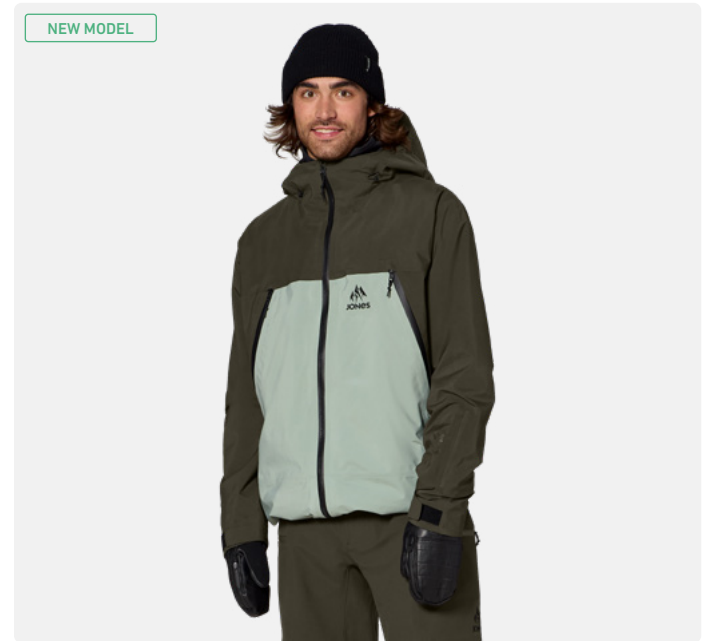

The new Deeper GORE-TEX Insulated Jacket is made for riders who keep going, no matter the conditions. Storm-proven protection with lightweight warmth.

- Best for staying warm when riding first lift to last, in all-conditions
- Storm-proven and breathable GORE-TEX 2L ePE recycled fabric
- Relaxed fit for comfort and dynamic movement

Performance

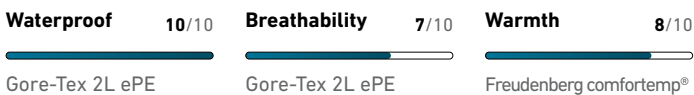

Materials



100% recycled 70D polyester GORE-TEX 2L ePE with PFC-Free DWR.
100% recycled polyester lining. 100% recycled Freudenberg comfotemp® insulation. Made with Bluesign certified fabrics.

Features

- | | | |
|----------------------------------|---------------------------------|------------------------------|
| Fully taped seams | Zipped armpit vents | Two internal dump pockets |
| Forearm pass pocket | Adjustable powder gaiter | Velcro adjustable cuffs |
| One zipped external chest pocket | Helmet compatible hood | Recycled zip pull cords |
| Two zipped hand pockets | Adjustable hood with cord locks | YKK Aquaguard zippers |
| | Adjustable hem with cord locks | YKK Natulon recycled zippers |

The new Deeper GORE-TEX 2L Jacket is super dependable and storm-ready, keeping you dry and comfortable from blower resort days to late spring laps.

- Best for riding blizzards to bluebirds, from first lift to last
- Storm-proven and breathable GORE-TEX 2L ePE recycled fabric
- Relaxed fit for comfort and dynamic movement

Performance

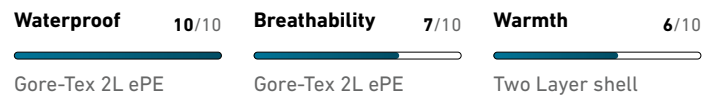

Materials



100% recycled 70D polyester GORE-TEX 2L ePE with PFC-Free DWR.
100% recycled polyester lining. Made with Bluesign certified fabrics.

Features

- | | | |
|------------------------------|---------------------------------|------------------------------|
| Fully taped seams | Adjustable powder gaiter | Two internal dump pockets |
| Forearm pass pocket | Helmet compatible hood | Recycled zip pull cords |
| Two zipped high hand pockets | Adjustable hood with cord locks | YKK Aquaguard zippers |
| Zipped armpit vents | Adjustable hem with cord locks | YKK Natulon recycled zippers |
| | Velcro adjustable cuffs | Five Red Flags print |

Men's Deeper GORE-TEX Pants



Proven protection in all conditions

Lined pant, comfortable, relaxed fit

Ideal for all-conditions resort and sidecountry adventures



GLACIER GRAY



STEALTH BLACK



MIDNIGHT GREEN

The new Deeper GORE-TEX Pants keep you dry, comfortable, and charging lines in all conditions, whatever mother nature throws your way.

- Best for riding from blizzard to bluebird, from first lift to last
- Storm-proven and breathable GORE-TEX 2L ePE recycled fabric
- Relaxed fit for comfort and dynamic movement

Performance

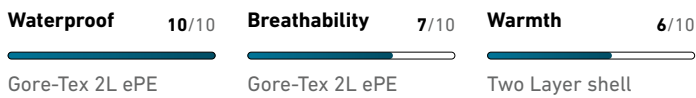

Materials



100% recycled materials



OEKO-Tex® Standard 100



PFC Free DWR



WRAP certified facilities



BSCI certified facilities

100% recycled 70D polyester GORE-TEX 2L ePE with PFC-Free DWR.
100% recycled polyester lining. Made with Bluesign certified fabrics.

Features

- | | | |
|----------------------------------|----------------------------------|------------------------------|
| Fully taped seams | Reinforced inner cuff fabric | YKK Natulon recycled zippers |
| Two zipped thigh pockets | Double snap front closure | Recycled zip pull cords |
| Internal phone sleeve & key loop | Adjustable waist with belt loops | Durable powder gaiters |
| Zipped side seam vents | YKK Aquaguard zippers | Durable kick patch |



SUPREME COMFORT, VERSATILITY AND PROTECTION

Men's Further 3L Stretch

Next level comfort meets ultimate versatility. Move with purpose, whether you're inbounds or pushing further into the backcountry.

Men's Further 3L Stretch Jacket

Stormproof protection, supreme comfort

Stormproof, versatile, supreme comfort

Ideal for resort ripping and backcountry touring



Men's Further 3L Stretch Pants

Stormproof protection, supreme comfort

Stormproof, versatile, supreme comfort

Ideal for resort ripping and backcountry touring



The redesigned Further 3L Stretch Jacket is made for mountain explorers whose adventures demand a stormproof shell that's as comfortable as it is functional.

- Best for bell-to-bell resort ripping and all-day backcountry touring
- Comfortable and stormproof 3L 30K/30K recycled stretch fabric
- Regular fit with articulated cut for unrestricted movement

Performance



Materials



100% recycled 70D polyester 4-way mechanical stretch 3-layer face fabric with 100% recycled 20D polyester backer. Dot laminated hydrophilic membrane, with PFC-Free DWR.

Features



- | | | |
|---|---------------------------------|--------------------------------|
| Fully taped seams | Two zipped high hand pockets | Two internal dump pockets |
| Forearm pass pocket | Zippered armpit vents | Adjustable hem with cord locks |
| Zippered external chest pocket with internal phone sleeve | Adjustable powder gaiter | Velcro adjustable cuffs |
| | Helmet compatible hood | Recycled zip pull cords |
| | Adjustable hood with cord locks | YKK Aquaguard zippers |

The Further 3L Stretch Pants are built for mountain explorers who need stormproof pants that are designed for dynamic movement and all-day comfort.

- Best for bell-to-bell resort ripping and all-day backcountry touring
- Comfortable and stormproof 3L 30K/30K recycled stretch fabric
- Regular fit with articulated cut for unrestricted movement

Performance



Materials



100% recycled 70D polyester 4-way mechanical stretch 3-layer face fabric with 100% recycled 20D polyester backer. Dot laminated hydrophilic membrane, with PFC-Free DWR.

Features



- | | | |
|--|----------------------------------|-------------------------|
| Fully taped seams | Reinforced inner cuff fabric | Recycled zip pull cords |
| Two zipped thigh pockets with internal phone sleeve on right side. | Adjustable waist with belt loops | RECCO equipped |
| Zippered side seam vents | YKK Aquaguard zippers | Durable powder gaiters |
| | YKK Natulon recycled zippers | Durable kick patch |



EVERYDAY PERFORMANCE FOR ALL CONDITIONS RIDING

Men's MTN Surf

Built to handle it all. Durable protection, everyday comfort,
and style that lasts for seasons.

Men's MTN Surf Insulated Jacket

Versatile warmth, everyday performance

Lightly insulated, comfortable, relaxed fit
Ideal for all-conditions, everyday performance

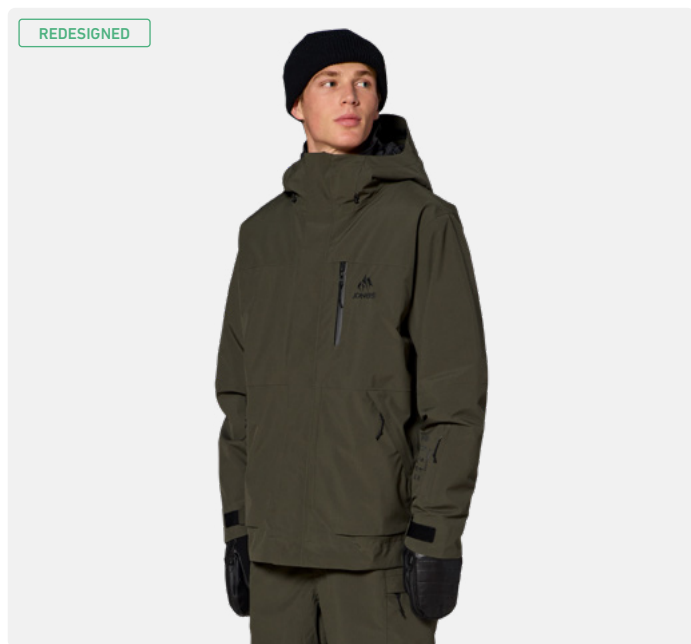

The MTN Surf Insulated Jacket is a super comfortable, lightly insulated jacket for shredders who want to ride-it-all.

- Best for everyday resort shredding in all conditions
- 20K/20K recycled fabrics for durability and breathability
- Longer length and lightly insulated for warmth and protection

Performance

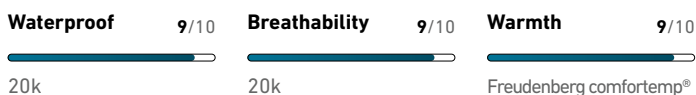

Materials



100% recycled 75D polyester 4-way mechanical 2-layer stretch ripstop face fabric. Fully laminated hydrophilic clear membrane with PFC-Free DWR. 100% recycled polyester lining. 100% recycled Freudenberg comfortemp® insulation. Made with Bluesign certified fabrics.

Features

Fully taped seams	Forearm pass pocket	Two internal dump pockets
Zippered external chest pocket	Zippered armpit vents	Adjustable hem with cord locks
Two zippered hand pockets	Adjustable powder gaiter	Velcro adjustable cuffs
Internal phone sleeve	Helmet compatible hood	Recycled zip pull cords
	Adjustable hood with cord locks	YKK Aquaguard zippers

Men's MTN Surf Jacket

All conditions versatility, everyday performance

Versatile, comfortable, relaxed fit
Ideal for all-conditions, everyday performance



The MTN Surf Jacket is a super comfortable, do-it-all jacket, redesigned with new high hand pockets, for shredders who ride bell-to-bell and earn their turns in any weather.

- Best for everyday resort shredding in all conditions
- 20K/20K recycled fabrics for durability and breathability
- Mid-length with a relaxed fit for comfort and protection

Performance



Materials



100% recycled 75D polyester 4-way mechanical 2-layer stretch ripstop face fabric. Fully laminated hydrophilic clear membrane with PFC-Free DWR. 100% recycled polyester lining. Made with Bluesign certified fabrics.

Features

Fully taped seams	Forearm pass pocket	Two internal dump pockets
Zippered external chest pocket	Zippered armpit vents	Adjustable hem with cord locks
Two zippered hand pockets	Adjustable powder gaiter	Velcro adjustable cuffs
Internal phone sleeve	Helmet compatible hood	Recycled zip pull cords
	Adjustable hood with cord locks	YKK Aquaguard zippers

Men's MTN Surf Bibs

All conditions versatility, everyday performance

Lined bib, comfortable, relaxed fit

Ideal for all-conditions, everyday performance

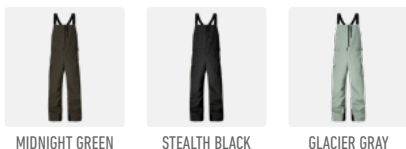
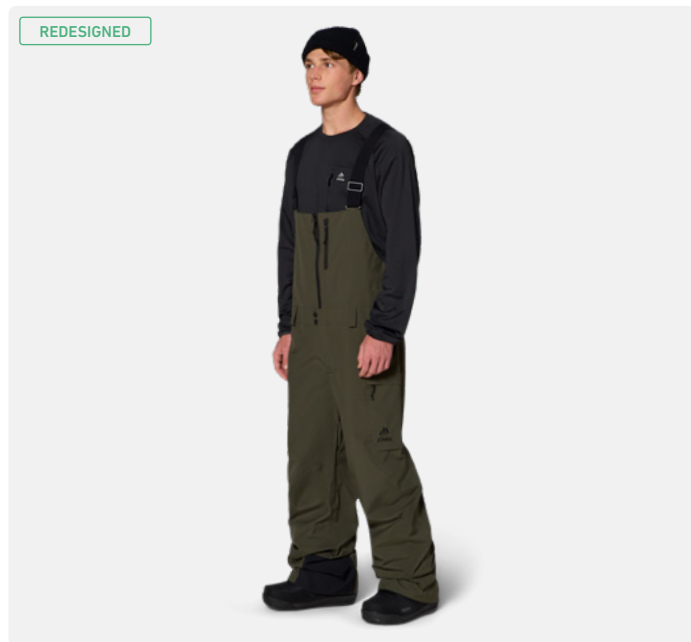

The newly redesigned MTN Surf Bibs are super comfortable and functional, with a more relaxed fit and full front zip entry made with 100% recycled fabrics that you can live in all season.

- Best for everyday resort shredding in all conditions
- 20K/20K recycled fabrics for durability and breathability
- Relaxed fit for unrestricted movement and slashing dynamic turns

Performance

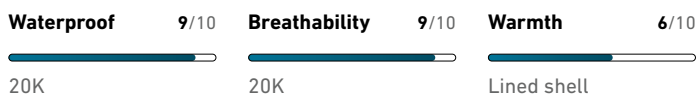

Materials



100% recycled 75D polyester 4-way mechanical 2-layer stretch ripstop face fabric. Fully laminated hydrophilic clear membrane with PFC-Free DWR. 100% recycled polyester lining. Made with Bluesign certified materials.

Features

- | | | |
|---|----------------------------------|-------------------------|
| Fully taped seams | Durable powder gaiters | Inseam vent zips |
| Two zipped thigh pockets with internal phone sleeve in right pocket | Reinforced inner cuff fabric | Recycled zip pull cords |
| | Adjustable waist with belt loops | Durable kick patch |
| | YKK Natulon recycled zippers | |

Men's MTN Surf Pants

All conditions versatility, everyday performance

Lined pant, comfortable, relaxed fit

Ideal for all-conditions, everyday performance



The MTN Surf Pants are stormproof shred pants made with 100% recycled fabrics that are as comfortable as your favorite jeans.

- Best for everyday resort shredding in all conditions
- 20K/20K recycled fabrics for durability and breathability
- Relaxed fit for unrestricted slashing and tossing dynamic tricks

Performance

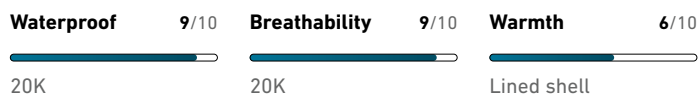

Materials



100% recycled 75D polyester 4-way mechanical 2-layer stretch ripstop face fabric. Fully laminated hydrophilic clear membrane with PFC-Free DWR. 100% recycled polyester lining. Made with Bluesign certified fabrics.

Features

- | | | |
|---|----------------------------------|------------------------------|
| Fully taped seams | Durable powder gaiters | Inseam vent zips |
| Two zipped thigh pockets with internal phone sleeve in right pocket | Reinforced inner cuff fabric | YKK Natulon recycled zippers |
| | Double snap front closure | Recycled zip pull cords |
| | Adjustable waist with belt loops | Durable kick patch |



STYLE WITHOUT BOUNDARIES

Unisex Tweaker

Ride your own way, with unrestricted movement, combined with trusted Jones outerwear protection.

Unisex Tweaker Jacket

All-conditions protection for hard-charging freestylers

Durable, comfortable, boxy cut

Ideal for all-conditions, everyday performance

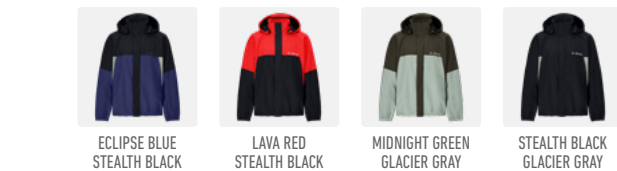
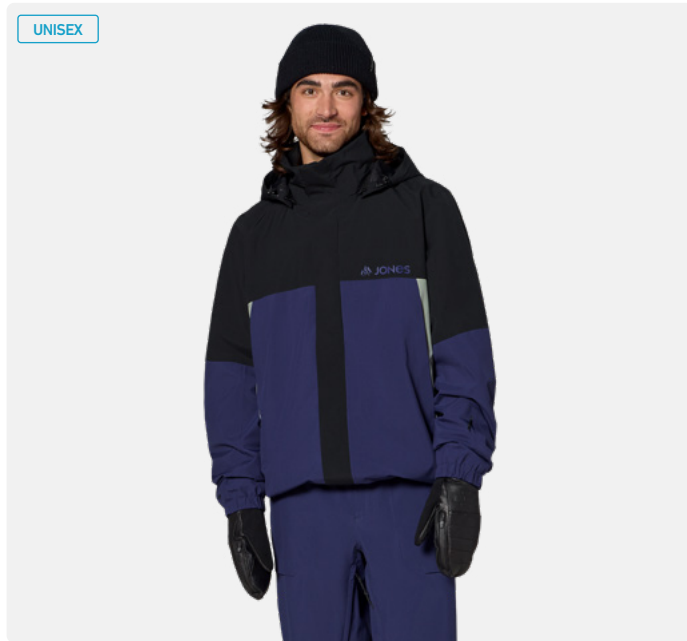

The Tweaker Jacket is a unisex shell made out of 100% recycled 20K / 20K 2L fabric that matches all-conditions protection with a boxy cut.

- Best for everyday resort shredding and park lapping
- 20K/20K recycled fabrics for durability and breathability
- Baggy fit for unrestricted slashing and tossing dynamic tricks

Performance

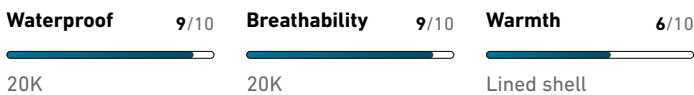

Materials



100% recycled 75D polyester 4-way mechanical 2-layer stretch ripstop face fabric. Fully laminated hydrophilic clear membrane with PFC-Free DWR. 100% recycled polyester lining. Made with Bluesign certified materials

Features

- | | | |
|--------------------------------|--------------------------------|--|
| Fully taped seams | Armpit vent zips | Forearm pass pocket |
| Zippered external chest pocket | Stow-away zip-off hood | Recycled zip pull cords |
| 2 zippered hand pockets | Adjustable hem with cord locks | Detachable, helmet-compatible, adjustable hood |
| Internal drop pocket | YKK Natulon recycled zippers | |

Unisex Tweaker Pants

All-conditions protection for hard-charging freestylers

Lined pant, comfortable, boxy cut

Ideal for all-conditions, everyday performance



The Tweaker Pants are unisex pants made out of 100% recycled 20K / 20K 2L fabric that match all-conditions protection with a boxy cut.

- Best for everyday resort shredding and park lapping
- 20K/20K recycled fabrics for durability and breathability
- Baggy fit for unrestricted slashing and tossing dynamic tricks

Performance



Materials



100% recycled 75D polyester 4-way mechanical 2-layer stretch ripstop face fabric. Fully laminated hydrophilic clear membrane with PFC-Free DWR. 100% recycled polyester lining. Made with Bluesign certified materials.

Features

- | | | |
|-----------------------------------|------------------------------|---------------|
| Fully taped seams | YKK Natulon recycled zippers | Elastic cuffs |
| Zippered back pocket | Recycled zip pull cords | |
| Zippered hand pockets | Durable kick patch | |
| Elastic waistband w/ webbing belt | Zippered inside vents | |



GUARANTEED PROTECTION IN ALL CONDITIONS

Women's Deeper GORE-TEX

Premium performance for the harshest conditions. Outerwear that delivers on every lap.

Women's Deeper GORE-TEX Insulated Jacket



All-conditions warmth, proven protection

Lightly insulated, comfortable, relaxed fit
Ideal for all-conditions resort and sidecountry adventures



STEALTH BLACK



ECLIPSE BLUE



GLACIER GRAY
MIDNIGHT GREEN

The new Deeper GORE-TEX Insulated Jacket is made for riders who keep going, no matter the conditions. Storm-proven protection with lightweight warmth.

- Best for staying warm when riding first lifts to last, in all-conditions
- Storm-proven and breathable GORE-TEX 2L ePE recycled fabric
- Relaxed fit for comfort and dynamic movement

Performance

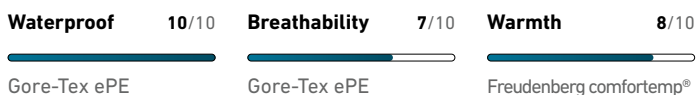

Materials



100% recycled 70D polyester GORE-TEX 2L ePE with PFC-Free DWR.
100% recycled polyester lining. 100% recycled Freudenberg comfotemp® insulation. Made with Bluesign certified fabrics.

Features

- | | | |
|----------------------------------|---------------------------------|------------------------------|
| Fully taped seams | Zipped armpit vents | 2 internal dump pockets |
| Forearm pass pocket | Adjustable powder gaiter | Velcro adjustable cuffs |
| One zipped external chest pocket | Helmet compatible hood | Recycled zip pull cords |
| Two zippered hand pockets | Adjustable hood with cord locks | YKK Aquaguard zippers |
| | Adjustable hem with cord locks | YKK Natulon recycled zippers |

Women's Deeper GORE-TEX Pants



Proven protection in all conditions

Lined pant, comfortable, relaxed fit
Ideal for all-conditions resort and sidecountry adventures

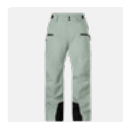

GLACIER GRAY

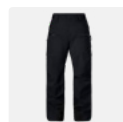

STEALTH BLACK

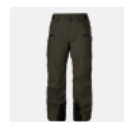

MIDNIGHT GREEN

The new Deeper GORE-TEX Pants keep you dry, comfortable, and charging lines in all conditions, whatever mother nature throws your way.

- Best for riding from blizzard to bluebird, from first lift to last
- Storm-proven and breathable GORE-TEX 2L ePE recycled fabric
- Relaxed fit for comfort and dynamic movement

Performance

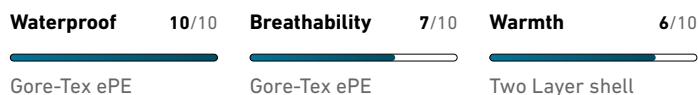

Materials



100% recycled 70D polyester GORE-TEX 2L ePE with PFC-Free DWR.
100% recycled polyester lining. Made with Bluesign certified fabrics.

Features

- | | | |
|--|----------------------------------|------------------------------|
| Fully taped seams | Durable powder gaiters | YKK Aquaguard zippers |
| Two zipped thigh pockets with internal phone sleeve on right side. | Reinforced inner cuff fabric | YKK Natulon recycled zippers |
| Zippered side seam vents | Double snap front closure | Recycled zip pull cords |
| | Adjustable waist with belt loops | Durable kick patch |



SUPREME COMFORT, VERSATILITY AND PROTECTION

Women's Further 3L Stretch

Next level comfort meets ultimate versatility. Move with purpose, whether you're inbounds or pushing further into the backcountry.

Women's Further 3L Stretch Jacket

Stormproof Protection, Supreme Comfort

Stormproof, versatile, supreme comfort

Ideal for resort ripping and backcountry touring



Women's Further 3L Stretch Pants

Stormproof Protection, Supreme Comfort

Stormproof, versatile, supreme comfort

Ideal for resort ripping and backcountry touring



The Further 3L Stretch Jacket is made for mountain explorers whose adventures demand a stormproof shell that's as comfortable as it is functional.

- Best for bell-to-bell resort ripping and all-day backcountry touring
- Comfortable and stormproof 3L 30K/30K recycled stretch fabric
- Regular fit with articulated cut for unrestricted movement

Performance



Materials



100% recycled 70D polyester 4-way mechanical stretch 3-layer face fabric with 100% recycled 20D polyester backer.

Dot laminated hydrophilic membrane, with PFC-Free DWR.

Features



- | | | |
|--|---------------------------------|--------------------------------|
| Fully taped seams | Two zipped high hand pockets | Two internal dump pockets |
| Forearm pass pocket | Zippered armpit vents | Adjustable hem with cord locks |
| Zippered vertical external chest pocket with internal phone sleeve | Adjustable powder gaiter | Velcro adjustable cuffs |
| | Helmet compatible hood | Recycled zip pull cords |
| | Adjustable hood with cord locks | YKK Aquaguard zippers |

The Further 3L Stretch Pants are built for mountain explorers who need stormproof pants that are designed for dynamic movement and all-day comfort .

- Best for bell-to-bell resort ripping and all-day backcountry touring
- Comfortable and stormproof 3L 30K/30K recycled stretch fabric
- Regular fit with articulated cut for unrestricted movement

Performance



Materials



100% recycled 70D polyester 4-way mechanical stretch 3-layer face fabric with 100% recycled 20D polyester backer.

Dot laminated hydrophilic membrane, with PFC-Free DWR.

Features



- | | | |
|--|----------------------------------|-------------------------|
| Fully taped seams | Reinforced inner cuff fabric | Recycled zip pull cords |
| Two zipped thigh pockets with internal phone sleeve on right side. | Adjustable waist with belt loops | RECCO equipped |
| Zippered side seam vents | YKK Aquaguard zippers | Durable powder gaiters |
| | YKK Natulon recycled zippers | Durable kick patch |



EVERYDAY PERFORMANCE FOR ALL CONDITIONS RIDING

Women's MTN Surf

Built to handle it all. Durable protection, everyday comfort, and style that lasts for seasons.

Women's MTN Surf Insulated Jacket

Versatile warmth, everyday performance

Lightly insulated, comfortable, relaxed fit
Ideal for all-conditions, everyday performance

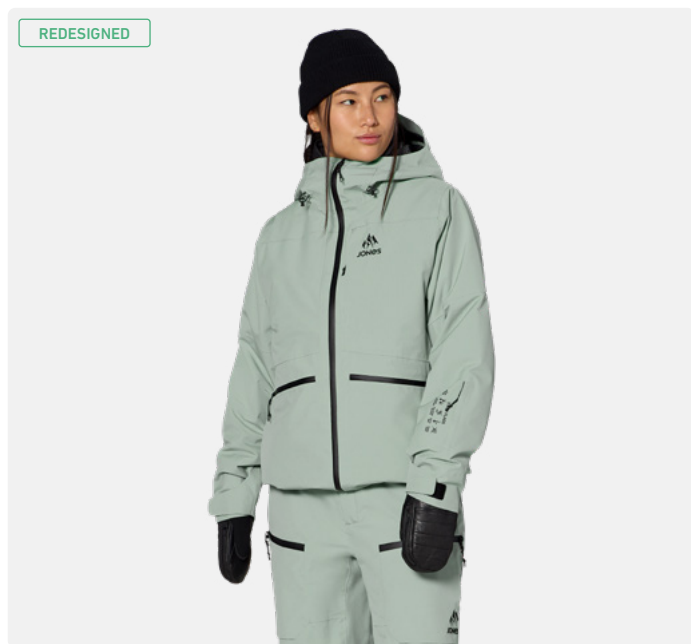

GLACIER GRAY



ECLIPSE BLUE
STEALTH BLACK



MIDNIGHT GREEN

The MTN Surf Jacket is a super comfortable, lightly insulated jacket for shredders who want to ride-it-all.

- Best for everyday resort shredding in all conditions
- 20K/20K recycled fabrics for durability and breathability
- Longer length and lightly insulated for warmth and protection

Performance

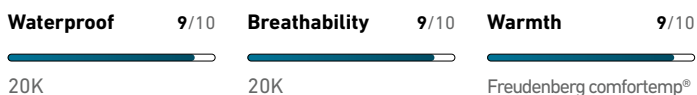

Materials



100% recycled 75D polyester 4-way mechanical 2-layer stretch ripstop face fabric. Fully laminated hydrophilic clear membrane with PFC-Free DWR. 100% recycled polyester lining. 100% recycled Freudenberg comfortemp® insulation. Made with Bluesign certified fabrics.

Features

- | | | |
|------------------------------------|---------------------------------|--------------------------------|
| Fully taped seams | Two internal mesh drop pockets | Two internal dump pockets |
| Forearm pass pocket | Zippered armpit vents | Adjustable hem with cord locks |
| One zippered external chest pocket | Minimalist powder skirt | Velcro adjustable cuffs |
| Two zippered hand pockets | Helmet compatible hood | Recycled zip pull cords |
| | Adjustable hood with cord locks | YKK Aquaguard zippers |

Women's MTN Surf Bibs

Versatile warmth, everyday performance

Lined bib, supreme comfort, relaxed fit
Ideal for all-conditions, everyday performance

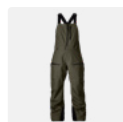

MIDNIGHT GREEN

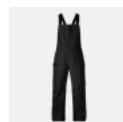

STEALTH BLACK



GLACIER GRAY

The newly redesigned MTN Surf Bibs are super comfortable and functional, with a more relaxed fit and full front zip entry made with 100% recycled fabrics that you can live in all season.

- Best for everyday resort shredding in all conditions
- 20K/20K recycled fabrics for durability and breathability
- Relaxed fit for unrestricted movement and slashing dynamic turns

Performance



Materials



100% recycled 75D polyester 4-way mechanical 2-layer stretch ripstop face fabric. Fully laminated hydrophilic clear membrane with PFC-Free DWR. 100% recycled polyester lining. Made with Bluesign certified fabrics.

Features

- | | | |
|--|----------------------------------|------------------------------|
| Fully taped seams | Easy access drop seat | YKK Aquaguard zippers |
| Two zippered thigh pockets with internal phone sleeves | Reinforced inner cuff fabric | YKK Natulon recycled zippers |
| Zippered side seam vents | Adjustable shoulder straps | Recycled zip pull cords |
| | Adjustable waist with belt loops | Durable powder gaiters |
| | | Durable kick patch |



RESPONSIBLE OUTERWEAR FOR EVERY ADVENTURE

Insulation & Fleece

Unisex Max Re-Up Down 750+ Hooded Jacket

Responsibly made performance, ultimate warmth

Warm, hooded, versatile, packable

Ideal for stand-alone warmth in the resort and backcountry

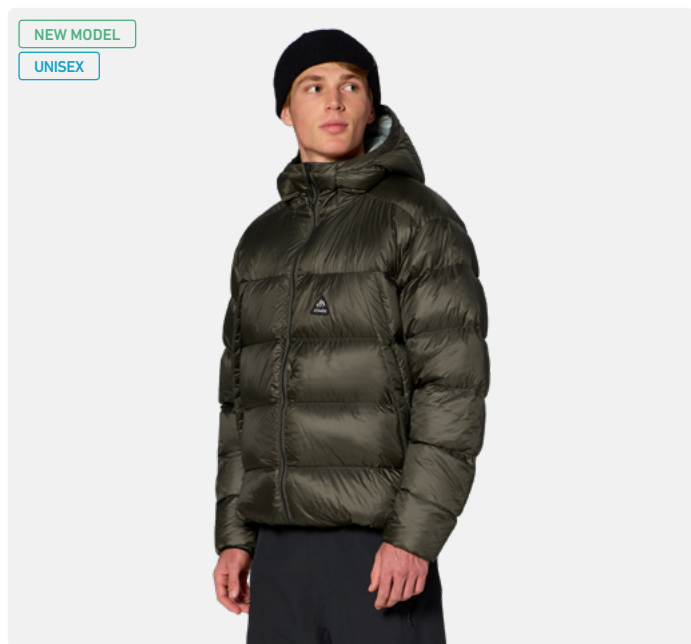

MIDNIGHT GREEN



STEALTH BLACK



GLACIER GRAY

Men's Dark Start Stretch Hooded Jacket

Dynamic warmth for dynamic days

Versatile warmth, breathable, supreme comfort

Ideal for high output adventures and every day warmth



MOSS GREEN

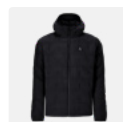

STEALTH BLACK

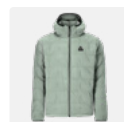

GLACIER GRAY

Built for the coldest climates, the Max Re-Up Down Hooded Jacket packs 750-fill RENU recycled down into a super warm layer for summit pushes and everyday wear.

- Best for mid-winter layering, maximum warmth, and versatility
- 100% recycled 750-fill RENU down & 100% recycled downproof face fabric
- Relaxed fit. Can be worn as outer layer.

Performance

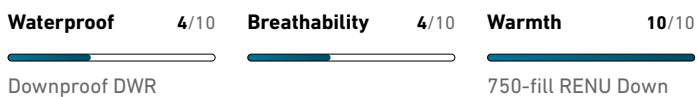

Materials



100% recycled 20D nylon fine ripstop with PFC-Free DWR. Ultra high performance 100% recycled 750-fill RENU down that is upcycled from retired down apparel.

Features

- | | |
|------------------------------|----------------------------------|
| Zipped external chest pocket | Stows in zipped internal pocket. |
| Two zippered hand pockets | Adjustable hem with cord locks |
| Two internal dump pockets | Elastic cuffs |
| Zipped internal chest pocket | Recycled zip pull cords |

The Dark Start Stretch Hooded Jacket is a technical insulation layer designed to keep you dry and warm when moving fast in the mountains.

- Best for high output adventures and everyday warmth
- 100% recycled synthetic Air Flake insulation & 100% recycled polyester face fabric
- Regular fit. Can be worn as mid or outer layer.

Performance

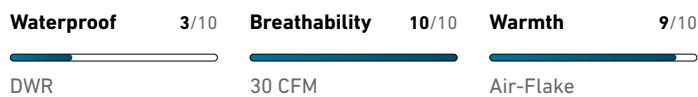

Materials



100% recycled 30D polyester 4-way stretch polyester with PFC-Free DWR. 100% recycled polyester Air Flake insulation.

Features

- | | |
|------------------------------|---------------------------------|
| Zipped external chest pocket | Recycled zip pull cords |
| Two zippered hand pockets | Stows in zipped external pocket |
| Two internal dump pockets | Adjustable hem with cord locks |
| Zipped external chest pocket | Elastic cuffs |

Men's Ultra Re-Up Down 750+ Jacket

Responsibly made performance, versatile warmth

Lightweight, minimalist, packable warmth
Ideal for layering at the resort and in the backcountry

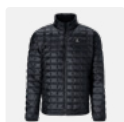

STEALTH BLACK



MIDNIGHT GREEN



GLACIER GRAY

The Ultra Re-Up Down Jacket is a technical down layer made with 100% recycled 750-fill RENU down that offers high performance warmth on cold days.

- Best for mid-winter layering and expeditions
- Made with 100% recycled 750-fill RENU down & 100% recycled nylon face fabric
- Regular fit. Can be worn as mid or outer layer.

Performance



Materials



100% recycled materials



Ultra High Performance 100% Recycled Down



OEKO-Tex Standard 100



PFC Free DWR



WRAP certified facilities



BSCI certified facilities

100% recycled 20D nylon fine ripstop with PFC-Free DWR. Ultra high performance 100% recycled 750-fill RENU down that is upcycled from retired down apparel.

Features

- Two hand pockets
- Two external dump pockets
- Zippered internal chest pocket
- Stuff and stow chest pocket
- Adjustable hem with cord locks
- Elastic cuffs
- Recycled zip pull cords

Men's Base Camp Fleece Jacket

Responsibly made technical mid-layer

Medium weight mid-layer, versatile, cozy warm
Ideal for casual layering and all-season warmth.



MIDNIGHT GREEN

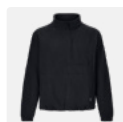

STEALTH BLACK



GLACIER GRAY

The updated Base Camp Fleece Jacket is a warm and versatile midweight polar fleece jacket made with 97% recycled polyester and 3% elastane.

- Best for everyday layering and warmth, on and off the mountain
- Updated soft polar fleece fabric made from 97% recycled polyester and 3% elastane
- Regular fit. Can be worn as mid or outer layer.

Materials



100% recycled materials



OEKO-Tex Standard 100



WRAP certified facilities

97% recycled polyester and 3% elastane.
Made with Bluesign certified fabrics.

Features

- One zippered chest pocket
- Two hand pockets
- Full center front zip
- Elastic cuffs & hem
- Adjustable hem with cord locks

Men's Lodge Fleece Pants

Casual look, technical performance

High performance mid-layer, casual style
Ideal for layering and every day comfort.

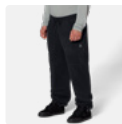

STEALTH BLACK

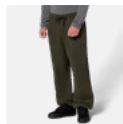

MIDNIGHT GREEN

The updated Lodge Fleece Pants are soft and supremely comfortable midweight polar fleece pants made out of 97% Recycled Polyester and 3% elastane.

- Best for resort or backcountry layering and everyday warmth
- Updated soft polar fleece fabric made with 97% recycled polyester and 3% elastane
- Regular fit for comfort and easy layering

Materials



Made with recycled materials



OEKO-Tex® Standard 100



WRAP certified facilities

91% recycled polyester and 9% elastane.
Made with Bluesign certified fabrics.

Features

- Two hand pockets
- Drawstring waist
- Elastic cuffs

Men's Flagship Grid Fleece Hooded Jacket

Responsibly made technical mid-layer

Lightweight mid-layer, warm, comfortable
Ideal for layering in all weather conditions.



MIDNIGHT GREEN



STEALTH BLACK



GLACIER GRAY

The new Flagship Grid Fleece Hooded Jacket is a technical lightweight fleece layer made with a breathable, stretch 91% recycled polyester and 9% elastane.

- Best for resort or backcountry layering and everyday warmth
- New grid fleece fabric made with soft, breathable 91% recycled polyester and 9% elastane
- Regular fit for easy layering under a shell

Materials



Made with recycled materials



OEKO-Tex® Standard 100



WRAP certified facilities

91% recycled polyester and 9% elastane.
Made with Bluesign certified fabrics.

Features

- Two hand pockets
- Phone sleeve inside the right hand pocket
- Elastic cuffs & hem

Men's Flagship Grid Fleece Crew

Casual look, technical performance

Lightweight mid-layer, warm, comfortable
Ideal for layering in all weather conditions.

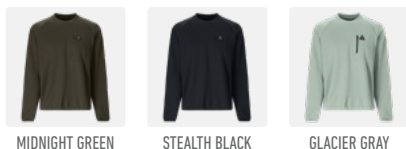

MIDNIGHT GREEN

STEALTH BLACK

GLACIER GRAY

The redesigned Flagship Grid Fleece Crew is a technical lightweight fleece layer made with a breathable, stretch 91% recycled polyester and 9% elastane.

- Best for resort or backcountry layering and everyday warmth
- New grid fleece fabric made with soft, breathable 91% recycled polyester and 9% elastane
- Regular fit for easy layering under a shell

Materials



Made with recycled materials



OEKO-Tex® Standard 100



WRAP certified facilities

91% recycled polyester and 9% elastane.
Made with Bluesign certified fabrics.

Features

Zipped chest pocket
Elastic cuffs & hem

Men's Shastarama Hooded Tech Tee

Casual look, technical performance

Lightweight, base-layer, hooded, comfortable
Ideal for layering and every day comfort

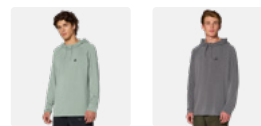

GLACIER GRAY

HEATHER GRAY

The redesigned Shastarama Hooded Tech Tee features a Naia™ blend of soft, breathable, moisture-wicking fabric, ideal for lightweight layering on the skintrack.

- Best for resort or backcountry layering and everyday adventures
- Made with soft, breathable and quick drying blend of 48% nylon, 47% Naia™ and 5% elastane
- Regular fit for easy layering under a shell

Materials



Made with recycled materials



WRAP certified facilities

48% Nylon, 47% Naia™ and 5% Elastane.
Made with Bluesign certified materials.

Features

Hood with drawstring
Cuff thumb loops

Men's Long Sleeve Tech Tee

Lightweight layering, technical performance

Lightweight, base-layer, long-sleeved, comfortable
Ideal for layering and every day comfort



GLACIER GRAY

HEATHER GRAY

The redesigned Long-Sleeve Tech Tee features a Naia™ blend of soft, breathable, moisture-wicking fabric, ideal for a fast drying, super versatile baselayer.

- Best for resort or backcountry layering and everyday adventures
- Made with soft, breathable and quick drying blend of 48% nylon, 47% Naia™ and 5% elastane
- Regular fit for easy layering under a shell

Materials



48% Nylon, 47% Naia™ and 5% Elastane.
Made with Bluesign certified materials.

Women's Campfire Fleece Jacket

Casual look, technical performance

High performance mid layer, casual style
Ideal for layering and every day comfort.



STEALTH BLACK

GLACIER GRAY

MIDNIGHT GREEN

The updated Campfire Fleece Jacket is a warm and versatile midweight polar fleece jacket made with 97% recycled polyester and 3% elastane.

- Best for resort or backcountry layering and everyday warmth
- Soft polar fleece fabric made with 97% recycled polyester and 3% elastane
- Regular fit. Can be worn as mid or outer layer.

Materials



91% recycled polyester and 9% elastane.
Made with Bluesign certified fabrics.

Features

- Two hand pockets
- Zip neck
- Elastic cuffs
- Adjustable hem with cord locks

Women's Flagship Grid Fleece Hooded Pullover

Responsibly made technical mid-layer

Lightweight mid-layer, warm, comfortable
Ideal for layering in all weather conditions.



MIDNIGHT GREEN



STEALTH BLACK



GLACIER GRAY

The new Flagship Grid Fleece Hooded Pullover is a technical lightweight fleece made with a breathable, stretch 91% recycled polyester and 9% elastane.

- Best for resort or backcountry layering and everyday warmth
- New grid fleece fabric made with soft, breathable 91% recycled polyester and 9% elastane
- Regular fit for easy layering under a shell

Materials



Made with recycled materials



OEKO-Tex® Standard 100



WRAP certified facilities

91% recycled polyester and 9% elastane.
Made with Bluesign certified fabrics.

Features

- Kangaroo pocket
- Phone sleeve inside kangaroo pocket
- Elastic cuffs and hem



EYE CATCHING, EARTH FRIENDLY MOUNTAIN LIFESTYLE WEAR

Responsible Apparel

Comfortable and eye-catching apparel featuring inspiring graphics
and made responsibly.

Tees & Hoodies

Truckee Organic Cotton Hoodie



GLACIER GRAY

STEALTH BLACK

MIDNIGHT GREEN



Organic Cotton



WRAP certified facilities

Truckee Organic Cotton Tee



ECLIPSE BLUE

STEALTH BLACK

MIDNIGHT GREEN



Organic Cotton



WRAP certified facilities

Sierra Organic Cotton Tee



GLACIER GRAY

STEALTH BLACK



Organic Cotton



WRAP certified facilities

Graphic Organic Cotton Long Sleeve



TWEAKER
STEALTH BLACK



Organic Cotton



WRAP certified facilities

Mountain Art Organic Cotton Tee

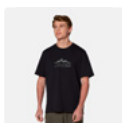

STEALTH BLACK



Organic Cotton



WRAP certified facilities

Headwear

Split Tech Cap



STEALTH BLACK

GLACIER GRAY



100%
Recycled Polyester



WRAP
certified facilities

Bootpack Tech Cap



STEALTH BLACK

GLACIER GRAY



100%
Recycled Polyester



WRAP
certified facilities

Trucker Cap

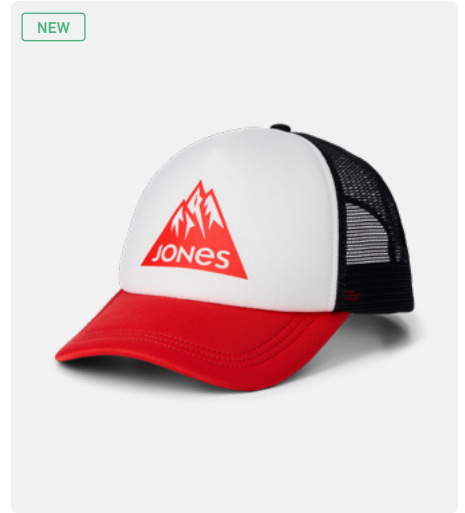

STEALTH BLACK

ECLIPSE BLUE

LAVA RED



WRAP
certified facilities

Fresh Corduroy Organic Cotton Cap



STEALTH BLACK

MIDNIGHT GREEN



Organic
Cotton



WRAP
certified facilities

Yuki Beanie

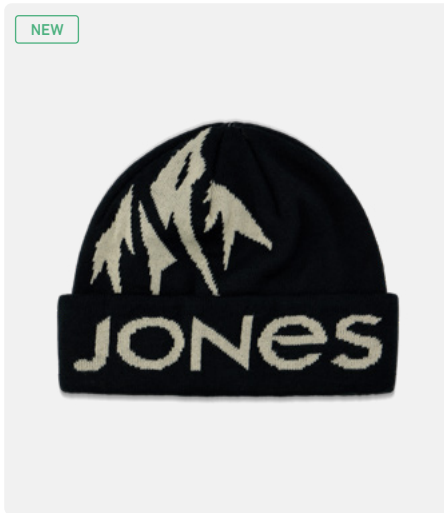

STEALTH BLACK

MIDNIGHT GREEN



100%
Recycled Polyester



Made with
Polyana® fiber



WRAP
certified facilities

Inaki Beanie



STEALTH BLACK

MIDNIGHT GREEN



Made with
Polyana® fiber



Made with
recycled materials



100% Acrylic
Free



WRAP
certified facilities

Headwear

Anchorage Beanie



STEALTH BLACK GLACIER GRAY MIDNIGHT GREEN



Tahoe Beanie



STEALTH BLACK ECLIPSE BLUE MIDNIGHT GREEN



Kodiak Beanie



STEALTH BLACK MIDNIGHT GREEN



Paliwood Fleece Beanie



STEALTH BLACK
MIDNIGHT GREEN ECLIPSE BLUE
GLACIER GRAY



MTN Logo Beanie



STEALTH BLACK MIDNIGHT GREEN



MTN Logo Neckwarmer



MTN LOGO



Flagship Neckwarmer



FLAGSHIP



Tweaker Neckwarmer



TWEAKER



MTN Twin Neckwarmer



MTN TWIN



Grid Fleece Neckwarmer



MIDNIGHT GREEN



Grid Fleece Neckwarmer



STEALTH BLACK



Grid Fleece Balaclavas



STEALTH BLACK



Grid Fleece Balaclavas



MIDNIGHT GREEN





FUNCTIONAL DESIGNS, MADE FOR MOVEMENT

Backpacks & Board Bags

Our packs are built to feel like a natural extension of your body
as you move through the mountains.



nes

Deeper 19L

The sleek sidecountry pack

Sidecountry, backcountry bare essentials
Ideal for sidecountry and quick tours



The Deeper 19L pack is a sleek sidecountry and quick tour pack that's the perfect size for the bare essentials - avy tools, water, snacks and a layer.

- Fleece lined goggle pocket + hydro pocket
- Thermo-molded foam back panel
- Hemet holder + ice axe loop
- Thermo-molded foam back panel
- Vertical board carry straps and side ski carry straps
- Avy tools slots + zippered internal pocket

Materials



100% recycled 600D ripstop polyester shell, 100% recycled polyester lining, PFC-Free DWR

Features

- | | |
|-----------------------------------|------------------------------------|
| A-frame split-ski carry mode | Hydro pocket with insulated sleeve |
| Ergonomic comfort shoulder straps | Integrated safety whistle |
| Internal zipper with key clip | Ice axe loop |

Further 25L

The mid-size tour pack

Mid-size, comfortable, streamlined fit
Ideal for intermediate backcountry tours



The Further 25L is a mid-size touring pack designed to hold everything you need for a basic backcountry mission.

- Fleece lined goggle pocket + hydro pocket
- Dual hip pockets + thermo-molded back panel
- Hemet holder + dual ice axe loops
- Thermo-molded foam back panel
- Vertical board carry straps and side ski carry straps
- Avy tools pocket with avy rescue protocol info panel

Materials



100% recycled 600D ripstop polyester shell, 100% recycled polyester lining, PFC-Free DWR

Features

- | | |
|------------------------------------|---------------------------|
| A-frame split-ski carry mode | Integrated safety whistle |
| Ergonomic comfort shoulder straps | Dual ice axe loops |
| Internal zipper with key clip | Dual hip belt pockets |
| Hydro pocket with insulated sleeve | Hip belt gear loop |

Higher 32L

The perfect splitboarding pack

All-day tours, back access, streamlined fit
Ideal for long technical backcountry tours



The Higher 32L is designed for long splitboard tours and technical objectives that demand you carry the full kit.

- Fleece lined goggle pocket + hydro pocket
- Dual hip pockets + thermo-molded back panel
- Helmet holder + dual ice axe loops
- Thermo-molded foam back panel
- Vertical board carry straps and side ski carry straps
- Avy tools pocket with avy rescue protocol info panel

Materials



100% recycled 600D ripstop polyester shell, 100% recycled polyester lining. PFC-Free DWR

Features

- | | |
|--------------------------------------|------------------------------------|
| A-frame split-ski carry mode | Hydro pocket with insulated sleeve |
| Back panel cargo access | Integrated safety whistle |
| Ergonomic comfort shoulder straps | Dual ice axe loops |
| Internal zipper pocket with key clip | Dual hip belt pockets |
| Water bottle pocket holder | Hip belt gear loop |

Escape Board Bag

The fully padded classic board bag

Lightweight, easy to carry, durable
Ideal for road trips, bus, train and quick plane travel



The Escape Board Bag is a fully padded bag designed for basic travel trips with your shred gear.

- Fully padded shell for solid protection
- Zippered exterior pocket for small gear
- Exterior ID window pocket
- Water resistant PVC-free exterior fabric
- Side carry handles and removable shoulder strap for easy transport
- Fits boards up to length 166cm

Materials



100% recycled 600D ripstop polyester shell, PFC-Free DWR, 100% recycled polyester lining

Features

- | | |
|---------------------------|--------------------------|
| Zippered interior pocket | Side carry handle |
| Removable shoulder strap | Fits up to a 166cm board |
| Exterior ID window pocket | |

Adventure Board Bag

The lightweight roller bag

Basic roller, fully padded, durable

Ideal for long distance road trips and place travel



The Adventure Board Bag is a lightweight, fully padded roller bag built to carry your board and shred gear on long distance travel trips.

- Fully padded shell for solid protection
- Oversized wheels and skid plate
- Internal compression straps to secure boards
- Water resistant PVC-free exterior fabric
- Zippered top lid pocket for accessories + window ID pocket
- Fits multiple boards up to length 166cm

Materials



100% recycled 600D ripstop polyester shell, PFC-Free DWR, 100% recycled polyester lining

Features

- Zippered interior pocket
- Exterior ID window pocket
- Top and side carry handles
- Fits up to a 166cm board

Expedition Board Bag

The ultimate roller bag

High volume roller, multiple pockets, durable

Ideal for long distance trips and international explorers

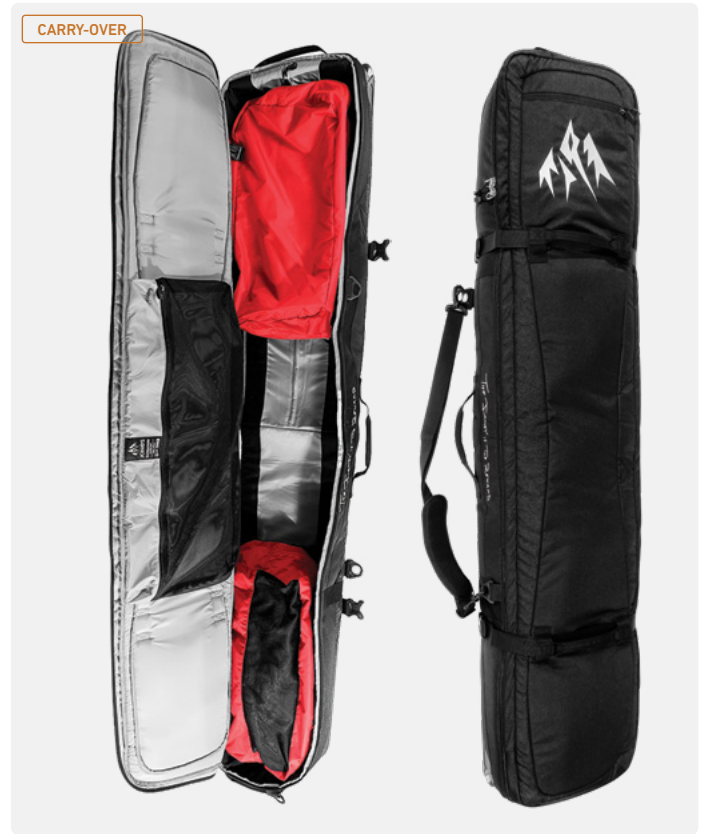

The Expedition Board Bag is a fully padded roller bag built to carry multiple boards and gear to any snowy location on the planet.

- Fully padded shell for solid protection
- Oversized wheels and skid plate
- Dual compression + main pocket board straps
- Water resistant PVC-free exterior fabric
- Zippered interior & exterior pockets, plus two removable pouch pockets
- Fits multiple boards up to length 166cm

Materials



100% recycled 600D ripstop polyester shell, PFC-Free DWR, 100% recycled polyester lining

Features

- Zippered interior pocket
- Exterior ID window pocket
- Removable shoulder strap
- Main pocket board strap
- Zippered, mesh interior pockets
- Dual, side, top & end carry handles
- Fits up to a 166cm board



TEST. TWEAK. REPEAT.

Product Specs & Tech

A full breakdown of the tech, shapes, and construction that drive the performance of every Jones board.

Outerwear Size Charts

MEN	XS	S	M	L	XL
Arm length	32.3 - 32.7 in 82 - 83 cm	32.7 - 33.1 in 83 - 84 cm	33.1 - 33.5 in 84 - 85 cm	33.5 - 34.3 in 85 - 87 cm	34.3 - 35.0 in 87 - 89 cm
Chest	34.1 - 36.4 in 86.5 - 92.5 cm	36.4 - 38.8 in 92.5 - 98.5 cm	38.8 - 40.9 in 99 - 104 cm	40.9 - 44.3 in 104.5 - 112.5 cm	44.3 - 47.2 in 112.5 - 120 cm
Waist	28.1 - 30.5 in 71.5 - 77.5 cm	30.5 - 32.9 in 77.5 - 83.5 cm	32.9 - 35.0 in 84 - 89 cm	35.0 - 38.4 in 90 - 97.5 cm	38.4 - 41.3 in 97.5 - 105 cm
Hip / Seat	33.7 - 36.0 in 85.5 - 91.5 cm	36.0 - 38.4 in 91.5 - 97.5 cm	38.4 - 40.6 in 98 - 103 cm	40.6 - 43.9 in 103.5 - 111.5 cm	43.9 - 46.9 in 111.5 - 119 cm
Inseam length	33.7 - 36.0 in 80.5 - 81.5 cm	32.1 - 32.5 in 91.5 - 97.5 cm	32.5 - 32.9 in 82.5 - 83.5 cm	32.9 - 33.3 in 83.5 - 84.5 cm	33.3 - 33.7 in 84.5 - 85.5 cm

WOMEN	XS	S	M	L	XL
Arm length	29.9 - 30.3 in 76 - 77 cm	30.3 - 30.7 in 77 - 78 cm	30.7 - 31.1 in 78 - 79 cm	31.1 - 31.5 in 79 - 80 cm	31.5 - 31.9 in 80 - 81 cm
Chest	31.5 - 33.5 in 80 - 85 cm	33.5 - 35.4 in 85 - 90 cm	35.4 - 37.4 in 90 - 95 cm	37.4 - 40.0 in 95.5 - 101.5 cm	40.0 - 42.9 in 102 - 109 cm
Waist	26.4 - 28.3 in 67 - 72 cm	28.3 - 30.1 in 72.5 - 76.5 cm	30.1 - 32.3 in 77 - 82 cm	32.3 - 34.8 in 82.5 - 88.5 cm	34.8 - 37.8 in 89 - 96 cm
Hip / Seat	34.3 - 36.2 in 87 - 92 cm	36.2 - 38.0 in 92.5 - 96.5 cm	38.0 - 40.2 in 97 - 102 cm	40.2 - 42.7 in 102.5 - 108.5 cm	42.7 - 45.7 in 109 - 116 cm
Inseam length	29.9 - 30.3 in 76 - 77 cm	30.3 - 30.7 in 77.5 - 78 cm	30.7 - 31.3 in 78.5 - 79.5 cm	31.3 - 32.1 in 80 - 81.5 cm	32.1 - 32.7 in 81.5 - 83 cm

Bindings Size Charts

FASE®	S	M	L
US Youth & Men's	5 - 8	8,5 - 10,5	11 - 14
US Women's	6,5 - 9,5	10 - 12	12,5 - 15,5
EU	37,5 - 41	41,5 - 44	44,5 - 48
UK	4 - 7	7,5 - 9,5	10 - 13
Mondo	23 - 26	26,5 - 28,5	29 - 31

MEN'S TRADITIONAL TWO-STRAP	S	M	L
US	5 - 7	7.5 - 10	10.5 +
EU	36.5 - 39.5	40 - 43	43.5 +
MD	23.5 - 25	25.5 - 28	28.5 +

WOMEN'S TRADITIONAL TWO-STRAP	S	M
US	5 - 8.5	9 - 11.5
EU	35 - 39.5	40 - 42.5
MD	22 - 25	25.5 - 27.5

YOUTH TRADITIONAL TWO-STRAP	XXS	XS	S
US	7C - 12C	12C - 4	4 - 7
EU	24 - 30.5	30 - 35.5	35 - 39.5
MD	13 - 18	18-23	22.5 - 26

Big Horn Series

Big feet? We've got you covered

The Big Horn Series identifies the boards in the Jones line designed for riders with big feet. These boards have a 26.3 cm or wider waist width for added performance on steep and hard snow. If you wear size US 11 boots or larger, look for the Big Horn Series sizes of most board models.

All-Mountain Freeride

Men's Flagship Pro	159W	26.3
	162W	26.3
	165W	26.6
Men's Flagship	159W	26.3
	162W	26.3
	165W	26.6
	169W	27.0
	172	26.3
Men's Howler	157W	26.4
	160W	26.7
	163W	27.0
	NEW 164	26.3
Men's Stratos	158W	26.3
	161W	26.4
	164W	26.5
Hovercraft 2.0	156	26.3
	160	26.7
	164	27.1
Men's Frontier 2.0	155W	26.3
	158W	26.5
	161W	26.7
	164W	26.9
	167W	27.1
Men's Ultralight Project X	NEW 161W	26.4
Men's Ultralight Solution	162W	26.3
	165W	26.6
Ultralight Hovercraft Split 2.0	156	26.3
	160	26.7
Men's Howler Split	NEW 160W	26.7
Men's Solution	159W	26.3
	162W	26.3
	165W	26.6
	169W	27.0
Men's Stratos Split	158W	26.3
	161W	26.4
Hovercraft Split 2.0	156	26.3
	160	26.7
Men's Frontier Split 2.0	158W	26.5
	161W	26.7
	164W	26.9

All-Mountain

Men's Aviator 2.0	159W	26.3
	163W	26.6
	162W	26.3
Men's Mountain Twin Pro	162W	26.3
	165W	26.7
Men's Mountain Twin	NEW 158UW	27.8
	NEW 161UW	28
	162W	26.3
	NEW 164UW	28.2
	165W	26.7
	168W	26.9
Men's Rally Cat	159W	26.3
	162W	26.5
	166W	26.7
	170W	26.9

All-Mountain Freestyle

Men's Tweaker Pro 2.0	157W	26.3
Men's Tweaker 2.0	157W	26.3
	160W	26.6

Freecarver series

Freecarver 6000s	154	26.3
	158	26.5
	162	26.7
Freecarver 9000s	152	26.8
	156	27.0
	160	27.2
	164	27.4

Surf series

TwinCraft	NEW 158	26.8
	NEW 162	27.2
Storm Wolf	162	26.4
Storm Chaser	142	26.6
	147	27.1
	152	27.5
	157	27.7
Mind Expander 2.0	NEW 162	26.4
	NEW 166	26.8
Storm Chaser Split	152	27.5













Board Specs

	Length (cm)	Weight range	Ideal boot size (Us men/women)	Ideal boot size (eur)	Big horn series	Flex	Board weight	Sidecut (m)	Effective edge length (cm)	Shaping waist width (cm)	Tip width (cm)	Tail width (cm)	Taper (mm)	Reference stance (cm)	Reference stance (in)	Skins group (pre-cut)	Skins group (trim-to-fit)
Freecarver 6000s	150	120-170 lbs. / 54-77 kg.	9-11	42-44.5	-	Medium	2.9kg / 6.3lbs	6.2	124.2	26.1	32.5	31.6	9	50	19.7	-	-
	150N	120-170 lbs. / 54-77 kg.	4-8.5	36-41.5	-	Medium	2.7kg / 5.9lbs	6.2	124.2	24.6	31.0	30.1	9	50	19.7	-	-
	154	130-180 lbs. / 59-82 kg.	10+	43.5+	✓	Medium	3kg / 6.6lbs	6.5	128	26.3	32.8	31.9	9	52	20.5	-	-
	154N	130-180 lbs. / 59-82 kg.	4-9.5	36-43	-	Medium	2.7kg / 5.9lbs	6.5	128	24.8	31.3	30.4	9	52	20.5	-	-
	158	150-200+ lbs. / 67-91+ kg.	10+	43.5+	✓	Medium	3.2kg / 7lbs	6.7	131.8	26.5	33.2	32.3	9	56	22	-	-
	158N	150-200+ lbs. / 67-91+ kg.	4-9.5	36-43	-	Medium	2.8kg / 6.2lbs	6.7	131.8	25	31.7	30.8	9	56	22	-	-
162	170-220+ lbs. / 77-100+ kg.	10.5+	44.5+	✓	Medium	3.3kg / 7.3lbs	6.9	135.6	26.7	33.5	32.6	9	56	22	-	-	
Freecarver 9000s	152	120-170 lbs. / 54-77 kg.	9.5+	43+	✓	Med-Stiff	3kg / 6.6lbs	9	126.2	26.8	31.5	30.6	9	52	20.5	-	-
	152N	120-170 lbs. / 54-77 kg.	4-9	36-42.5	-	Med-Stiff	2.7kg / 5.9lbs	9	126.2	24.8	29.5	28.6	9	52	20.5	-	-
	156	130-180 lbs. / 59-82 kg.	10-16	43.5+	✓	Med-Stiff	3.1kg / 6.8lbs	9.2	130	27	31.9	31.0	9	54	21.3	-	-
	156N	130-180 lbs. / 59-82 kg.	4-9.5	37-43	-	Med-Stiff	2.8kg / 6.2lbs	9.2	130	25	29.9	29.0	9	54	21.3	-	-
	160	150-200+ lbs. / 67-91+ kg.	10+	43.5+	✓	Med-Stiff	3.3kg / 7.2lbs	9.4	133.8	27.2	32.2	31.3	9	56	22	-	-
	164	170-220+ lbs. / 77-100+ kg.	10+	43.5+	✓	Med-Stiff	3.4kg / 7.5lbs	9.6	137.6	27.4	32.6	31.7	9	56	22	-	-
TwinCraft	NEW 146	110-160 lbs. / 49-73 kg.	7-9	39.5-41.5	-	Medium	2.4kg / 5.3lbs	6.3	107.4	25.6	29.0	29.0	0	54	21.3	-	-
	NEW 150	120-170 lbs. / 54-77 kg.	8+	41+	-	Medium	2.6kg / 5.8lbs	6.5	110.6	26	29.5	29.5	0	56	22	-	-
	NEW 154	130-180 lbs. / 59-82 kg.	8+	41+	-	Medium	2.8kg / 6.2lbs	6.7	113.8	26.4	30.1	30.1	0	56	22	-	-
	NEW 158	150-200+ lbs. / 67-91+ kg.	10+	43.5+	✓	Medium	3kg / 6.7lbs	6.9	117	26.8	30.6	30.6	0	58	22.8	-	-
	NEW 162	170-220+ lbs. / 77-100+ kg.	11+	44.5+	✓	Medium	3.2kg / 7lbs	7.1	120.2	27.2	31.1	31.1	0	60	23.6	-	-
Mind Expander 2.0	NEW 142	90-140 lbs. / 41-63 kg.	7-9	39.5-41.5	-	Medium	2.4kg / 5.3lbs	6.6 / 6	103.4	24.8	28.8	27.8	10	50	19.7	-	-
	NEW 146	110-160 lbs. / 49-73 kg.	7-9	39.5-41.5	-	Medium	2.5kg / 5.6lbs	6.8 / 6.2	106.8	25.1	29.3	28.3	10	52	20.5	-	-
	NEW 150	120-170 lbs. / 54-77 kg.	7-9	39.5-41.5	-	Medium	2.8kg / 6.2lbs	7 / 6.4	110.2	25.4	29.7	28.7	10	54	21.3	-	-
	NEW 154	130-180 lbs. / 59-82 kg.	9-11	41.5-44.5	-	Medium	3kg / 6.6lbs	7.2 / 6.6	113.6	25.7	30.2	29.2	10	54	21.3	-	-
	NEW 158	150-200 lbs. / 67-91 kg.	9.5-11.5	42.5-45.5	-	Medium	3.2kg / 7lbs	7.4 / 6.8	117	26	30.6	29.6	10	56	22	-	-
	NEW 162	170-220+ lbs. / 77-100+ kg.	11+	44.5+	✓	Medium	3.4kg / 7.5lbs	7.6 / 7	120.2	26.4	31.1	30.1	10	58	22.8	-	-
	NEW 166	170-220+ lbs. / 77-100+ kg.	11+	44.5+	✓	Medium	3.6kg / 7.9lbs	7.8 / 7.2	123.4	26.8	31.7	30.7	10	60	23.6	-	-
Storm Chaser	142	120-170 lbs. / 54-77 kg.	7-9	39.5-41.5	✓	Medium	2.6kg / 5.6lbs	6.3	98.8	26.6	31.1	29.0	20.3	50	19.7	-	-
	147	130-180 lbs. / 59-82 kg.	9+	41.5+	✓	Medium	2.7kg / 5.9lbs	6.6	102.8	27.1	31.7	29.7	20.3	56	22	-	-
	152	140-190 lbs. / 63-86 kg.	10+	43.5+	✓	Medium	2.9kg / 6.4lbs	6.9	107	27.5	32.2	30.2	20	56	22	-	-
	157	150-200 lbs. / 67-91 kg.	11+	44.5+	✓	Medium	3.1kg / 6.9lbs	7.2	111.6	27.7	32.7	30.7	19.8	56	22	-	-
	162	160-210+ lbs. / 73-95+ kg.	10+	43.5+	✓	Med-Stiff	3.2kg / 7lbs	8.8	121	26.4	30.3	29.5	8.6	58	22.8	-	-
Storm Wolf	150	120-170 lbs. / 54-77 kg.	8+	41+	-	Med-Stiff	2.7kg / 5.9lbs	8.2	109.5	25.9	29.3	28.5	8.2	54	21.3	-	-
	154	120-170 lbs. / 54-77 kg.	9-11	41.5-44.5	-	Med-Stiff	2.9kg / 6.3lbs	8.4	113	26.1	29.7	28.8	8.3	56	22	-	-
	158	130-180 lbs. / 59-82 kg.	8+	41+	-	Med-Stiff	3kg / 6.6lbs	8.6	117	26.2	29.9	29.1	8.5	58	22.8	-	-
	162	160-210+ lbs. / 73-95+ kg.	10+	43.5+	✓	Med-Stiff	3.2kg / 7lbs	8.8	121	26.4	30.3	29.5	8.6	58	22.8	-	-
	166	170-220+ lbs. / 77-100+ kg.	11+	44.5+	✓	Medium	3.6kg / 7.9lbs	7.8 / 7.2	123.4	26.8	31.7	30.7	10	60	23.6	-	-
Hovercraft 2.0	144	90-140 lbs. / 41-63 kg.	0-9	0-39.5	-	Medium	2.6kg / 5.7lbs	8.1	112.9	25.1	29.7	28.0	17	49	19.3	-	-
	148	90-140 lbs. / 41-63 kg.	7-9	39.5-41.5	-	Medium	2.7kg / 5.9lbs	8.4	116.1	25.5	30.2	28.5	17	50	19.7	-	-
	152	110-160 lbs. / 49-73 kg.	7-9	39.5-41.5	-	Medium	2.9kg / 6.4lbs	8.7	119.3	25.9	30.6	28.9	17	52	20.5	-	-
	156	130-180 lbs. / 59-82 kg.	9+	41.5+	✓	Medium	3.1kg / 6.8lbs	9	122.5	26.3	31.1	29.4	17	54	21.3	-	-
	160	160-210 lbs. / 73-95 kg.	11+	44.5+	✓	Medium	3.2kg / 7.1lbs	9.3	125.7	26.7	31.6	29.9	17	56	22	-	-
	164	170-220 lbs.+ / 77-100 kg.+	11+	44.5+	✓	Medium	3.3kg / 7.4lbs	9.6	128.9	27.1	32.1	30.4	17	56	22	-	-
	166	170-220+ lbs. / 77-100+ kg.	11+	44.5+	✓	Medium	3.4kg / 7.5lbs	9.6	128.9	27.1	32.1	30.4	17	56	22	-	-
Ultralight Butterfly Split	150	110-160 lbs. / 49-73 kg.	7-9	39.5-41.5	-	Med-Stiff	2.5kg / 5.6lbs	8.5	123.6	25.3	29.9	29.1	8	52	20.5	D	M
	154	130-180 lbs. / 59-82 kg.	8-10	40.5-43.5	-	Med-Stiff	2.7kg / 5.9lbs	8.8	127	25.6	30.3	29.5	8	54	21.3	D	M
	158	160-210 lbs. / 73-95 kg.	9.5-11.5	42.5-45.5	-	Med-Stiff	2.8kg / 6.1lbs	9.1	130.4	25.9	30.7	29.9	8	58	22.8	C	M
Ultralight Hovercraft 2.0 Split	152	110-160 lbs. / 49-73 kg.	7-9	39.5-41.5	-	Medium	2.5kg / 5.6lbs	8.7	119.3	25.9	30.6	28.9	17	54	21.3	C	M
	156	130-180 lbs. / 59-82 kg.	9+	41.5+	✓	Medium	2.7kg / 5.9lbs	9	122.5	26.3	31.1	29.4	17	56	22	C	M
	160	160-210 lbs. / 73-95 kg.	11+	44.5+	✓	Medium	2.8kg / 6.2lbs	9.3	125.7	26.7	31.6	29.9	17	58	22.8	E	M
Hovercraft 2.0 Split	148	90-140 lbs. / 41-63 kg.	7-9	39.5-41.5	-	Medium	2.8kg / 6.1lbs	8.4	116.1	25.5	30.2	28.5	17	52	20.5	C	S
	152	110-160 lbs. / 49-73 kg.	7-9	39.5-41.5	-	Medium	2.9kg / 6.3lbs	8.7	119.3	25.9	30.6	28.9	17	54	21.3	C	M
	156	130-180 lbs. / 59-82 kg.	9+	41.5+	✓	Medium	3.1kg / 6.7lbs	9	122.5	26.3	31.1	29.4	17	56	22	C	M
	160	160-210 lbs. / 73-95 kg.	11+	44.5+	✓	Medium	3.2kg / 7.1lbs	9.3	125.7	26.7	31.6	29.9	17	58	22.8	E	M
Storm Chaser Split	152	140-190 lbs. / 64-86 kg.	10+	43.5+	✓	Medium	3.1kg / 6.8lbs	6.9	107	27.5	32.2	30.2	20	58	22.8	I	S
Men's Ultralight Project X	156	120-190 lbs. / 54-77 kg.	8-11	40.5-44.5	-	Medium	2.5kg / 5.5lbs	7.2	116	25.4	30.3	29.3	10	54	21.3	-	-
	159	140-190 lbs. / 64-86 kg.	9-11	41.5-44.5	-	Medium	2.5kg / 5.5lbs	7.5	118.6	25.6	30.5	29.5	10	56	22	-	-
	NEW 161W	150-200 lbs. / 67-91 kg.	11+	44.5+	✓	Medium	2.7kg / 5.9lbs	7.7	120.4	26.4	31.3	30.3	10	56	22	-	-
Men's Flagship Pro	154	120-170 lbs. / 54-77 kg.	7-9	39.5-41.5	-	Stiff	2.4kg / 5.3lbs	7.9	114.2	24.6	29.2	27.8	13.6	52	20.5	-	-
	158	130-180 lbs. / 59-82 kg.	7-9	39.5-41.5	-	Stiff	2.7kg / 6lbs	8.5	117.6	24.9	29.4	28.1	12	56	22	-	-
	159W	140-190 lbs. / 64-86 kg.	11+	44.5+	✓	Stiff	2.6kg / 5.7lbs	8.7	118	26.3	30.7	29.5	12.7	56	22	-	-
	161	150-200 lbs. / 67-91 kg.	8.5-10.5	41.5-44	-	Stiff	2.9kg / 6.4lbs	9.1	120	25.2	29.6	28.3	12	56	22	-	-
	162W	160-210 lbs. / 73-95 kg.	11+	44.5+	✓	Stiff	3kg / 6.6lbs	9.3	121	26.3	30.7	29.4	12	56	22	-	-
	164	160-210 lbs. / 73-95 kg.	9-11	41.5-44.5	-	Stiff	3kg / 6.6lbs	9.3	122.6	25.4	29.9	28.6	12	56	22	-	-
	165W	170-220 lbs.+ / 77-100 kg.+	11+	44.5+	✓	Stiff	3.1kg / 6.9lbs	9.4	123.4	26.6	31.1	29.8	12	60	23.6	-	-

	Length (cm)	Weight range	Ideal boot size (Us men/women)	Ideal boot size (eur)	Big horn series	Flex	Board weight	Sidecut (m)	Effective edge length (cm)	Shaping waist width (cm)	Tip width (cm)	Tail width (cm)	Taper (mm)	Reference stance (cm)	Reference stance (in)	Skins group (pre-cut)	Skins group (trim-to-fit)	
Men's Flagship	151	120-170 lbs. / 54-77 kg.	7-9	39.5-41.5	-	Med-Stiff	2.7kg / 5.9lbs	7.3	111.8	24.3	29.0	27.6	14.3	50	19.7	-	-	
	154	120-170 lbs. / 54-77 kg.	7-9	39.5-41.5	-	Med-Stiff	2.8kg / 6.2lbs	7.9	114.2	24.6	29.2	27.8	13.6	52	20.5	-	-	
	156W	130-180 lbs. / 59-82 kg.	11+	44.5+	-	Med-Stiff	3kg / 6.7lbs	8.3	115.6	26.1	30.6	29.2	13.1	56	22	-	-	
	158	130-180 lbs. / 59-82 kg.	7-9	39.5-41.5	-	Med-Stiff	2.9kg / 6.5lbs	8.5	117.6	24.9	29.4	28.1	13	56	22	-	-	
	159W	140-190 lbs. / 64-86 kg.	11+	44.5+	✓	Med-Stiff	3.1kg / 6.9lbs	8.7	118	26.3	30.7	29.5	12.7	56	22	-	-	
	161	140-190 lbs. / 64-86 kg.	8.5-10.5	41.5-44	-	Med-Stiff	3.1kg / 6.8lbs	9.1	120	25.2	29.6	28.3	12.3	56	22	-	-	
	162W	160-210 lbs. / 73-95 kg.	11+	44.5+	✓	Med-Stiff	3.3kg / 7.2lbs	9.3	121	26.3	30.7	29.4	12.2	56	22	-	-	
	164	160-210 lbs. / 73-95 kg.	9-11	41.5-44.5	-	Med-Stiff	3.2kg / 7.1lbs	9.3	122.6	25.4	29.9	28.6	12.3	56	22	-	-	
	165W	160-210 lbs. / 73-95 kg.	11+	44.5+	✓	Med-Stiff	3.2kg / 7.4lbs	9.4	123.4	26.6	31.1	29.8	12.3	60	23.6	-	-	
	167	160-210 lbs. / 73-95 kg.	9-11	41.5-44.5	-	Med-Stiff	3.4kg / 7.5lbs	9.4	124.6	25.9	30.5	29.2	12.5	60	23.6	-	-	
	169W	170-220 lbs.+ / 77-100 kg.+	12+	46+	✓	Med-Stiff	3.6kg / 7.9lbs	9.5	126.6	27	31.7	30.4	12.5	62	24.4	-	-	
	172	170-220 lbs.+ / 77-100 kg.+	11+	44.5+	✓	Med-Stiff	3.6kg / 7.9lbs	9.5	128.8	26.3	31.1	29.8	12.7	62	24.4	-	-	
Men's Howler	152	130-180 lbs. / 59-82 kg.	8.5-10.5	41.5-44	-	Med-Stiff	2.6kg / 5.7lbs	8	117.7	25.1	29.4	28.6	8	52	20.5	-	-	
	155	140-190 lbs. / 64-86 kg.	9-11	41.5-44.5	-	Med-Stiff	2.7kg / 5.9lbs	8.2	120.1	25.4	29.8	29.0	8	54	21.3	-	-	
	157W	160-210 lbs.+ / 73-95 kg.+	9+	41.5+	✓	Med-Stiff	2.8kg / 6.2lbs	8.4	121.5	26.4	30.8	30.0	8	56	22	-	-	
	158	160-210 lbs.+ / 73-95 kg.+	9-11	41.5-44.5	-	Med-Stiff	2.8kg / 6.2lbs	8.4	122.5	25.7	30.2	29.4	8	56	22	-	-	
	160W	160-210 lbs.+ / 73-95 kg.+	11+	44.5+	✓	Med-Stiff	3kg / 6.6lbs	8.6	123.9	26.7	31.2	30.4	8	56	22	-	-	
	161	170-220 lbs.+ / 77-100 kg.+	9.5-11.5	42.5-45.5	-	Med-Stiff	2.9kg / 6.4lbs	8.6	124.9	26	30.6	29.8	8	56	22	-	-	
	163W	170-220 lbs.+ / 77-100 kg.+	11+	44.5+	✓	Med-Stiff	3.1kg / 6.8lbs	8.8	126.3	27	31.6	30.8	8	56	22	-	-	
	NEW 164	170-220 lbs.+ / 77-100 kg.+	9.5-11.5	42.5-45.5	✓	Med-Stiff	3.2kg / 7.1lbs	8.8	126.3	26.3	30.9	30.1	8	56	22	-	-	
Men's Stratos	149	110-160 lbs. / 49-73 kg.	7-9	39.5-41.5	-	Medium	2.6kg / 5.6lbs	6.5	110.2	24.2	29.0	28.0	10	50	19.7	-	-	
	153	120-170 lbs. / 54-77 kg.	7-9	39.5-41.5	-	Medium	2.8kg / 6.2lbs	6.8	113.8	24.8	29.7	28.7	10	52	20.5	-	-	
	154W	130-180 lbs. / 59-82 kg.	9-11	41.5-44.5	-	Medium	2.9kg / 6.4lbs	7.1	114	26.1	30.9	29.9	10	54	21.3	-	-	
	156	120-170 lbs. / 54-77 kg.	9-11	41.5-44.5	-	Medium	2.9kg / 6.5lbs	7.2	116	25.4	30.3	29.3	10	54	21.3	-	-	
	158W	140-190 lbs. / 64-86 kg.	11+	44.5+	✓	Medium	3.1kg / 6.7lbs	7.4	117.6	26.3	31.2	30.2	10	56	22	-	-	
	159	140-190 lbs. / 64-86 kg.	9-11	41.5-44.5	-	Medium	3kg / 6.7lbs	7.5	118.6	25.6	30.5	29.5	10	56	22	-	-	
	161W	150-200 lbs. / 67-91 kg.	11+	44.5+	✓	Medium	3.2kg / 7.1lbs	7.7	120.4	26.4	31.3	30.3	10	56	22	-	-	
	162	150-200 lbs. / 67-91 kg.	9-11	41.5-44.5	-	Medium	3.2kg / 7lbs	7.8	121.2	25.8	30.7	29.7	10	56	22	-	-	
	164W	160-210 lbs.+ / 73-95 kg.+	11+	44.5+	✓	Medium	3.3kg / 7.3lbs	8	123.2	26.5	31.4	30.4	10	60	23.6	-	-	
	Men's Frontier 2.0	150	110-160 lbs. / 49-73 kg.	7-9	39.5-41.5	-	Med-Soft	2.5kg / 5.5lbs	7.2	114.3	24.6	29.1	28.6	5	50	19.7	-	-
		153	110-160 lbs. / 49-73 kg.	7-9	39.5-41.5	-	Med-Soft	2.6kg / 5.8lbs	7.4	116.7	24.9	29.4	28.9	5	52	20.5	-	-
		155W	120-170 lbs. / 54-77 kg.	9.5-11.5	42.5-45.5	✓	Med-Soft	2.8kg / 6.2lbs	7.6	117.9	26.3	30.8	30.3	5	54	21.3	-	-
156		120-170 lbs. / 54-77 kg.	8-10	40.5-43.5	-	Med-Soft	2.7kg / 6lbs	7.6	119.1	25.2	29.8	29.3	5	54	21.3	-	-	
158W		140-190 lbs. / 64-86 kg.	10+	43+	✓	Med-Soft	2.9kg / 6.4lbs	7.8	120.5	26.5	31.1	30.6	5	56	22	-	-	
159		140-190 lbs. / 64-86 kg.	9-11	41.5-44.5	-	Med-Soft	2.9kg / 6.3lbs	7.8	121.5	25.5	30.2	29.7	5	56	22	-	-	
161W		150-200 lbs. / 67-91 kg.	11+	44.5+	✓	Med-Soft	3kg / 6.6lbs	8	123.1	26.7	31.4	30.9	5	56	22	-	-	
162		160-210 lbs. / 73-95 kg.	9-11	41.5-44.5	-	Med-Soft	3kg / 6.6lbs	8	123.9	25.8	30.5	30.0	5	56	22	-	-	
164W		170-220 lbs.+ / 77-100 kg.+	11+	44.5+	✓	Med-Soft	3.1kg / 6.8lbs	8.2	125.7	26.9	31.7	31.2	5	60	23.6	-	-	
165		170-220 lbs.+ / 77-100 kg.+	9-11	41.5-44.5	-	Med-Soft	3.2kg / 7lbs	8.2	126.3	26.1	30.9	30.4	5	60	23.6	-	-	
167W		170-220 lbs.+ / 77-100 kg.+	11+	44.5+	✓	Med-Soft	3.3kg / 7.3lbs	8.4	128.3	27.1	31.9	31.4	5	60	23.6	-	-	
Men's Aviator 2.0		147	110-160 lbs. / 49-73 kg.	7-9	39.5-41.5	-	Med-Stiff	2.5kg / 5.5lbs	7.1	113.8	24.2	28.2	28.2	0	50	19.7	-	-
	150	120-170 lbs. / 54-77 kg.	7-9	39.5-41.5	-	Med-Stiff	2.7kg / 6lbs	7.3	116.2	24.5	28.5	28.5	0	50	19.7	-	-	
	153W	130-180 lbs. / 59-82 kg.	9-11	41.5-44.5	-	Med-Stiff	2.9kg / 6.3lbs	7.4	118.2	25.9	30.0	30.0	0	52	20.5	-	-	
	154	130-180 lbs. / 59-82 kg.	9-11	41.5-44.5	-	Med-Stiff	2.8kg / 6.1lbs	7.5	119.4	24.9	29.0	29.0	0	52	20.5	-	-	
	156	140-190 lbs. / 64-86 kg.	9-11	41.5-44.5	-	Med-Stiff	2.9kg / 6.3lbs	7.6	121	25.1	29.3	29.3	0	54	21.3	-	-	
	157W	160-210 lbs.+ / 73-95 kg.+	11+	44.5+	-	Med-Stiff	3kg / 6.7lbs	7.65	121.8	26.1	30.3	30.3	0	56	22	-	-	
	158	150-200 lbs. / 67-91 kg.	9-11	41.5-44.5	-	Med-Stiff	3kg / 6.5lbs	7.7	122.6	25.3	29.5	29.5	0	56	22	-	-	
	159W	170-220 lbs.+ / 77-100 kg.+	11+	44.5+	✓	Med-Stiff	3.1kg / 6.8lbs	7.9	123.4	26.3	30.5	30.5	0	56	22	-	-	
	160	150-200 lbs. / 67-91 kg.	9-11	41.5-44.5	-	Med-Stiff	3kg / 6.6lbs	7.9	124.2	25.5	29.8	29.8	0	56	22	-	-	
	162	160-210 lbs.+ / 73-95 kg.+	9-11	41.5-44.5	-	Med-Stiff	3.1kg / 6.8lbs	8.2	126	25.6	29.8	29.8	0	56	22	-	-	
	163W	170-220 lbs.+ / 77-100 kg.+	11+	44.5+	✓	Med-Stiff	3.3kg / 7.3lbs	8.4	126.8	26.6	30.8	30.8	0	56	22	-	-	
	Men's Mountain Twin Pro	154	120-170 lbs. / 54-77 kg.	7-9	39.5-41.5	-	Med-Stiff	2.7kg / 6lbs	7.6	118.6	25.1	29.2	29.2	0	54	21.3	-	-
156W		130-180 lbs. / 59-82 kg.	9.5-11	42.5-44.5	-	Med-Stiff	2.9kg / 6.3lbs	7.7	120.4	25.9	30.1	30.1	0	56	22	-	-	
157		130-180 lbs. / 59-82 kg.	9-11	41.5-44.5	-	Med-Stiff	2.9kg / 6.4lbs	7.8	121	25.4	29.6	29.6	0	58	22.8	-	-	
159W		140-190 lbs. / 64-86 kg.	10-12	43.5-46	-	Med-Stiff	3kg / 6.6lbs	7.9	123	26.1	30.4	30.4	0	58	22.8	-	-	
160		150-200 lbs. / 67-91 kg.	9-11	41.5-44.5	-	Med-Stiff	3kg / 6.6lbs	8	123.4	25.7	30.0	30.0	0	58	22.8	-	-	
162W		150-200 lbs. / 67-91 kg.	11+	44.5+	✓	Med-Stiff	3.1kg / 6.9lbs	8.1	125.6	26.3	30.7	30.7	0	58	22.8	-	-	
163		160-210 lbs. / 73-95 kg.	9.5-11.5	42.5-45.5	-	Med-Stiff	3.1kg / 6.9lbs	8.2	125.8	26	30.3	30.3	0	58	22.8	-	-	
165W	170-220 lbs.+ / 77-100 kg.+	11+	44.5+	✓	Med-Stiff	3.3kg / 7.2lbs	8.3	127.8	26.7	31.1	31.1	0	58	22.8	-	-		

Board Specs

	Length (cm)	Weight range	Ideal boot size (Us men/women)	Ideal boot size (eur)	Big horn series	Flex	Board weight	Sidecut (m)	Effective edge length (cm)	Shaping waist width (cm)	Tip width (cm)	Tail width (cm)	Taper (mm)	Reference stance (cm)	Reference stance (in)	Skins group (pre-cut)	Skins group (trim-to-fit)
Men's Mountain Twin	149	110-160 lbs. / 49-73 kg.	7-9	39.5-41.5	-	Medium	2.4kg / 5.3lbs	7.2	115	24.4	28.5	28.5	0	52	20.5	-	-
	151	110-160 lbs. / 49-73 kg.	7-9	39.5-41.5	-	Medium	2.5kg / 5.6lbs	7.4	116.2	24.8	28.9	28.9	0	52	20.5	-	-
	153W	120-170 lbs. / 54-77 kg.	9.5-11	42.5-44.5	-	Medium	2.7kg / 5.9lbs	7.5	117.8	25.7	29.8	29.8	0	54	21.3	-	-
	154	120-170 lbs. / 54-77 kg.	7-9	39.5-41.5	-	Medium	2.6kg / 5.8lbs	7.6	118.6	25.1	29.2	29.2	0	54	21.3	-	-
	156W	130-180 lbs. / 59-82 kg.	9.5-11	42.5-44.5	-	Medium	2.7kg / 6lbs	7.7	120.4	25.9	30.1	30.1	0	56	22	-	-
	157	130-180 lbs. / 59-82 kg.	9-11	41.5-44.5	-	Medium	2.8kg / 6.1lbs	7.8	121	25.4	29.6	29.6	0	58	22.8	-	-
	NEW 158UW	140-190 lbs. / 64-86 kg.	11.5+	45.5+	✓	Medium	3.2kg / 7lbs	7.8	122	27.8	32.1	32.1	0	58	22.8	-	-
	159W	140-190 lbs. / 64-86 kg.	10-12	43.5-46	-	Medium	2.9kg / 6.3lbs	7.9	123	26.1	30.4	30.4	0	58	22.8	-	-
	160	150-200 lbs. / 67-91 kg.	9-11	41.5-44.5	-	Medium	2.9kg / 6.3lbs	8	123.4	25.7	30.0	30.0	0	58	22.8	-	-
	NEW 161UW	150-200 lbs. / 67-91 kg.	11.5+	45.5+	✓	Medium	3.3kg / 7.2lbs	8	124.6	28	32.4	32.4	0	58	22.8	-	-
	162W	150-200 lbs. / 67-91 kg.	11+	44.5+	✓	Medium	3kg / 6.7lbs	8.1	125.6	26.3	30.7	30.7	0	58	22.8	-	-
	163	160-210 lbs. / 73-95 kg.	9.5-11.5	42.5-45.5	-	Medium	3kg / 6.6lbs	8.2	125.8	26	30.3	30.3	0	58	22.8	-	-
	NEW 164UW	170-220 lbs.+ / 77-100 kg.+	11.5+	45.5+	✓	Medium	3.4kg / 7.5lbs	8.2	127.2	28.2	32.6	32.6	0	58	22.8	-	-
	165W	170-220 lbs.+ / 77-100 kg.+	11+	44.5+	✓	Medium	3.2kg / 7lbs	8.3	127.8	26.7	31.1	31.1	0	58	22.8	-	-
168W	170-220 lbs.+ / 77-100 kg.+	11+	44.5+	✓	Medium	3.3kg / 7.2lbs	8.5	130.4	26.9	31.4	31.4	0	58	22.8	-	-	
Men's Rally Cat	151	110-160 lbs. / 49-73 kg.	7-9	39.5-41.5	-	Med-Soft	2.4kg / 5.4lbs	7	111.4	24.7	28.8	28.8	0	50	19.7	-	-
	154	120-170 lbs. / 54-77 kg.	7-9	39.5-41.5	✓	Med-Soft	2.5kg / 5.6lbs	7.3	113.8	25	29.1	29.1	0	52	20.5	-	-
	155W	130-180 lbs. / 59-82 kg.	9.5-11	42.5-44.5	✓	Med-Soft	2.7kg / 6lbs	7.4	115	25.8	30.0	30.0	0	54	21.3	-	-
	156	130-180 lbs. / 59-82 kg.	9-11	41.5-44.5	-	Med-Soft	2.7kg / 5.8lbs	7.5	115.4	25.2	29.4	29.4	0	54	21.3	-	-
	158	140-190 lbs. / 64-86 kg.	9-11	41.5-44.5	-	Med-Soft	2.8kg / 6.1lbs	7.7	117	25.4	29.6	29.6	0	56	22	-	-
	159W	150-200 lbs. / 67-91 kg.	11+	44.5+	✓	Med-Soft	2.8kg / 6.2lbs	7.8	118	26.3	30.5	30.5	0	56	22	-	-
	161	150-200 lbs. / 67-91 kg.	9-11	41.5-44.5	-	Med-Soft	2.8kg / 6.3lbs	8	119.4	25.7	29.9	29.9	0	56	22	-	-
	162W	160-210 lbs. / 73-95 kg.	11+	44.5+	✓	Med-Soft	2.9kg / 6.5lbs	8.2	120.6	26.5	30.7	30.7	0	56	22	-	-
	166W	170-220 lbs.+ / 77-100 kg.+	11+	44.5+	✓	Med-Soft	3.1kg / 6.7lbs	8.6	124.2	26.7	30.9	30.9	0	60	23.6	-	-
	170W	170-220 lbs.+ / 77-100 kg.+	11+	44.5+	✓	Med-Soft	3.3kg / 7.2lbs	8.9	127.8	26.9	31.2	31.2	0	62	24.4	-	-
Men's Tweaker Pro	NEW 149	110-160 lbs. / 49-73 kg.	7-9	39.5-41.5	-	Med-Stiff	2.6kg / 5.8lbs	7.3	115.8	24.8	29.2	29.2	0	52	20.5	-	-
	NEW 151	110-160 lbs. / 49-73 kg.	7-9	39.5-41.5	-	Med-Stiff	2.7kg / 6lbs	7.4	117.4	25	29.4	29.4	0	54	21.3	-	-
	NEW 154	120-170 lbs. / 54-77 kg.	7-9	39.5-41.5	-	Med-Stiff	2.8kg / 6.2lbs	7.5	120	25.2	29.8	29.8	0	54	21.3	-	-
	NEW 156	130-180 lbs. / 59-82 kg.	9-11	41.5-44.5	-	Med-Stiff	2.9kg / 6.4lbs	7.6	121.6	25.4	30.0	30.0	0	56	22	-	-
	NEW 157W	130-180 lbs. / 59-82 kg.	11+	44.5+	✓	Med-Stiff	3kg / 6.7lbs	7.7	122.6	26.3	31.0	31.0	0	56	22	-	-
	NEW 159	140-190 lbs. / 64-86 kg.	9-11	41.5-44.5	-	Med-Stiff	3kg / 6.7lbs	7.7	124	25.7	30.5	30.5	0	56	22	-	-
Men's Tweaker	NEW 149	110-160 lbs. / 49-73 kg.	7-9	39.5-41.5	-	Med-Soft	2.6kg / 5.6lbs	7.3	115.8	24.8	29.2	29.2	0	52	20.5	-	-
	NEW 151	110-160 lbs. / 49-73 kg.	7-9	39.5-41.5	-	Med-Soft	2.6kg / 5.7lbs	7.4	117.4	25	29.4	29.4	0	54	21.3	-	-
	NEW 154	120-170 lbs. / 54-77 kg.	7-9	39.5-41.5	-	Med-Soft	2.8kg / 6.1lbs	7.5	120	25.2	29.8	29.8	0	54	21.3	-	-
	NEW 156	130-180 lbs. / 59-82 kg.	9-11	41.5-44.5	-	Med-Soft	2.8kg / 6.2lbs	7.6	121.6	25.4	30.0	30.0	0	56	22	-	-
	NEW 157W	130-180 lbs. / 59-82 kg.	11+	44.5+	✓	Med-Soft	3kg / 6.5lbs	7.7	122.6	26.3	31.0	31.0	0	56	22	-	-
	NEW 159	140-190 lbs. / 64-86 kg.	9-11	41.5-44.5	-	Med-Soft	2.9kg / 6.4lbs	7.7	124	25.7	30.5	30.5	0	56	22	-	-
	NEW 160W	150-200 lbs. / 67-91 kg.	11+	44.5+	✓	Med-Soft	3.1kg / 6.8lbs	7.8	125	26.6	31.4	31.4	0	56	22	-	-
	NEW 162	160-210 lbs. / 73-95 kg.	9-11	41.5-44.5	-	Med-Soft	3.1kg / 6.8lbs	7.8	126.4	26	30.9	30.9	0	58	22.8	-	-
Men's Ultralight Solution	158	130-180 lbs. / 59-82 kg.	7-9	39.5-41.5	-	Stiff	2.7kg / 6lbs	8.5	117.6	24.9	29.4	28.1	13	58	22.8	B	M
	161	150-200 lbs. / 67-91 kg.	8.5-10.5	41.5-44	-	Stiff	2.8kg / 6.2lbs	9.1	120	25.2	29.6	28.3	12.3	58	22.8	B	M
	162W	160-210 lbs. / 73-95 kg.	11+	44.5+	✓	Stiff	2.9kg / 6.4lbs	9.3	121	26.3	30.7	29.4	12.2	58	22.8	F	L
	164	160-210 lbs. / 73-95 kg.	9-11	41.5-44.5	-	Stiff	2.9kg / 6.3lbs	9.3	122.6	25.4	29.9	28.6	12.3	58	22.8	D	L
	165W	170-220+ lbs. / 77-100+ kg.	11+	44.5+	✓	Stiff	3kg / 6.6lbs	9.4	123.4	26.6	31.1	29.8	12.3	58	22.8	E	L
Men's Solution	154	120-170 lbs. / 54-77 kg.	7-9	39.5-41.5	-	Med-Stiff	2.9kg / 6.4lbs	7.9	114.2	24.6	29.2	27.8	13.6	54	21.3	B	M
	158	130-180 lbs. / 59-82 kg.	7-9	39.5-41.5	-	Med-Stiff	3.1kg / 6.8lbs	8.5	117.6	24.9	29.4	28.1	13	58	22.8	B	M
	159W	140-190 lbs. / 64-86 kg.	11+	44.5+	✓	Med-Stiff	3.2kg / 7lbs	8.7	118	26.3	30.7	29.5	12.7	58	22.8	G	M
	161	140-190 lbs. / 64-86 kg.	8.5-10.5	41.5-44	-	Med-Stiff	3.1kg / 6.8lbs	9.1	120	25.2	29.6	28.3	12.3	58	22.8	B	M
	162W	160-210 lbs. / 73-95 kg.	11+	44.5+	✓	Med-Stiff	3.3kg / 7.3lbs	9.3	121	26.3	30.7	29.4	12.2	58	22.8	F	L
	164	160-210 lbs. / 73-95 kg.	9-11	41.5-44.5	-	Med-Stiff	3.2kg / 7lbs	9.3	122.6	25.4	29.9	28.6	12.3	58	22.8	D	L
	165W	160-210 lbs. / 73-95 kg.	11+	44.5+	✓	Med-Stiff	3.4kg / 7.5lbs	9.4	123.4	26.6	31.1	29.8	12.3	58	22.8	E	L
	167	160-210 lbs. / 73-95 kg.	9-11	41.5-44.5	-	Med-Stiff	3.4kg / 7.5lbs	9.4	124.6	25.9	30.5	29.2	12.5	58	22.8	F	L
	169W	170-220+ lbs. / 77-100+ kg.	12+	46+	✓	Med-Stiff	3.6kg / 7.9lbs	9.5	126.6	27	31.7	30.4	12.5	60	23.6	H	L
Men's Howler Split	NEW 158	160-210 lbs.+ / 73-95 kg.+	9-11	41.5-44.5	-	Med-Stiff	3kg / 6.6lbs	8.4	122.5	25.7	30.2	29.4	8	58	22.8	D	M
	NEW 160W	160-210 lbs.+ / 73-95 kg.+	11+	44.5+	✓	Med-Stiff	3.2kg / 7lbs	8.6	123.9	26.7	31.2	30.4	8	58	22.8	G	M
	NEW 161	170-220 lbs.+ / 77-100 kg.+	9.5-11.5	42.5-45.5	-	Med-Stiff	3.1kg / 6.8lbs	8.6	124.9	26	30.6	29.8	8	58	22.8	D	L
Men's Stratos Split	156	120-170 lbs. / 54-77 kg.	9-11	41.5-44.5	-	Medium	3.1kg / 6.8lbs	7.2	116	25.4	30.3	29.3	10	56	22	C	M
	158W	140-190 lbs. / 64-86 kg.	11+	44.5+	✓	Medium	3kg / 6.6lbs	7.4	117.6	26.3	31.2	30.2	10	58	22.8	G	M
	159	140-190 lbs. / 64-86 kg.	9-11	41.5-44.5	-	Medium	3kg / 6.6lbs	7.5	118.6	25.6	30.5	29.5	10	58	22.8	D	M
	161W	150-200 lbs. / 67-91 kg.	11+	44.5+	✓	Medium	3.2kg / 7lbs	7.7	120.4	26.4	31.3	30.3	10	58	22.8	G	M

	Length (cm)	Weight range	Ideal boot size (Us men/women)	Ideal boot size (eur)	Big horn series	Flex	Board weight	Sidecut (m)	Effective edge length (cm)	Shaping waist width (cm)	Tip width (cm)	Tail width (cm)	Taper (mm)	Reference stance (cm)	Reference stance (in)	Skins group (pre-cut)	Skins group (trim-to-fit)
Men's Frontier 2.0 Split	156	120-170 lbs. / 54-77 kg.	8-10	40.5-43.5	-	Med-Soft	3,1kg / 6,7lbs	7.6	119.1	25.2	29.8	29.3	5	56	22	B	M
	158W	140-190 lbs. / 64-86 kg.	10+	43+	✓	Med-Soft	3,2kg / 7,1lbs	7.8	120.5	26.5	31.1	30.6	5	58	22.8	G	M
	159	140-190 lbs. / 64-86 kg.	9-11	41.5-44.5	-	Med-Soft	3,2kg / 7,1lbs	7.8	121.5	25.5	30.2	29.7	5	58	22.8	B	M
	161W	150-200 lbs. / 67-91 kg.	11+	44.5+	✓	Med-Soft	3,3kg / 7,3lbs	8	123.1	26.7	31.4	30.9	5	58	22.8	G	M
	162	160-210 lbs. / 73-95 kg.	9-11	41.5-44.5	-	Med-Soft	3,3kg / 7,4lbs	8	123.9	25.8	30.5	30.0	5	58	22.8	B	L
	164W	170-220+ lbs. / 77-100+ kg.	11+	44.5+	✓	Med-Soft	3,6kg / 7,9lbs	8.2	125.7	26.9	31.7	31.2	5	58	22.8	G	L
Women's Flagship	143	100-150 lbs. / 45-68 kg.	5-7	35.5-37.5	-	Med-Stiff	2,2kg / 4,9lbs	6.9	104.6	23.5	28.0	26.5	14.1	49	19.3	-	-
	146	100-150 lbs. / 45-68 kg.	5-7	35.5-37.5	-	Med-Stiff	2,4kg / 5,3lbs	7.1	107.2	23.7	28.2	26.8	14.1	49	19.3	-	-
	149	100-150 lbs. / 45-68 kg.	6-8	36.5-38.5	-	Med-Stiff	2,5kg / 5,4lbs	7.3	109.8	23.9	28.5	27.1	14.1	51	20.1	-	-
	152	110-160 lbs. / 49-73 kg.	7-9	37.5-40.5	-	Med-Stiff	2,6kg / 5,7lbs	7.5	112.4	24.1	28.8	27.4	14	51	20.1	-	-
	155	110-160 lbs. / 49-73 kg.	8-10	38.5-41.5	-	Med-Stiff	2,7kg / 5,8lbs	7.8	115	24.3	29.0	27.6	13.8	51	20.1	-	-
Women's Howler	 142	90-140 lbs. / 41-63 kg.	5-7	35.5-37.5	-	Med-Stiff	2,3kg / 5,1lbs	7.2	109.1	24.1	28.2	27.4	8	47	18.5	-	-
	 145	100-150 lbs. / 45-68 kg.	6-8	36.5-38.5	-	Med-Stiff	2,3kg / 5,1lbs	7.4	111.7	24.3	28.5	27.7	8	49	19.3	-	-
	 148	110-160 lbs. / 49-73 kg.	7-10	37.5-41.5	-	Med-Stiff	2,4kg / 5,3lbs	7.6	114.3	24.5	28.8	28.0	8	49	19.3	-	-
	 151	110-160 lbs. / 49-73 kg.	8-11	39-43	-	Med-Stiff	2,5kg / 5,5lbs	7.8	116.9	24.7	29.1	28.3	8	51	20.1	-	-
Women's Stratos	140	90-140 lbs. / 41-63 kg.	5-7	35.5-37.5	-	Medium	2,1kg / 4,6lbs	5.9	103	23.3	27.9	26.9	10	47	18.5	-	-
	143	100-150 lbs. / 45-68 kg.	5-7	35.5-37.5	-	Medium	2,3kg / 5,1lbs	6.1	105.4	23.6	28.3	27.3	10	49	19.3	-	-
	146	100-150 lbs. / 45-68 kg.	6-8	36.5-38.5	-	Medium	2,5kg / 5,4lbs	6.3	107.8	23.9	28.6	27.6	10	49	19.3	-	-
	149	110-160 lbs. / 49-73 kg.	7-9	37.5-39.5	-	Medium	2,6kg / 5,6lbs	6.5	110.2	24.2	29.0	28.0	10	51	20.1	-	-
	152	110-160 lbs. / 49-73 kg.	8-10	38.5-41.5	-	Medium	2,7kg / 6lbs	6.7	112.8	24.4	29.3	28.3	10	51	20.1	-	-
	155	110-160 lbs. / 49-73 kg.	8-11	38.5-43	-	Medium	2,8kg / 6,1lbs	6.9	115.2	24.7	29.7	28.7	10	51	20.1	-	-
Women's Dream Weaver 2.0	139	90-140 lbs. / 41-63 kg.	5-7	35.5-37.5	-	Med-Soft	2kg / 4,5lbs	6.5	104.5	23.5	27.6	27.1	5	47	18.5	-	-
	142	90-140 lbs. / 41-63 kg.	5-7	35.5-37.5	-	Med-Soft	2,1kg / 4,7lbs	6.7	107.1	23.7	27.9	27.4	5	47	18.5	-	-
	145	100-150 lbs. / 45-68 kg.	6-8	36.5-38.5	-	Med-Soft	2,2kg / 4,9lbs	6.9	109.7	23.9	28.2	27.7	5	49	19.3	-	-
	148	100-150 lbs. / 45-68 kg.	6-8	36.5-38.5	-	Med-Soft	2,3kg / 5lbs	7.1	112.3	24.1	28.5	28.0	5	49	19.3	-	-
	151	110-160 lbs. / 49-73 kg.	7-9	37.5-39.5	-	Med-Soft	2,4kg / 5,4lbs	7.3	114.9	24.3	28.7	28.2	5	51	20.1	-	-
	154	120-170 lbs. / 54-77 kg.	8-10	38.5-42	-	Med-Soft	2,5kg / 5,6lbs	7.5	117.5	24.5	29.0	28.5	5	51	20.1	-	-
	156	120-170 lbs. / 54-77 kg.	8-11	38.5-43	-	Med-Soft	2,6kg / 5,7lbs	7.7	119.1	24.7	29.2	28.7	5	53	20.9	-	-
Women's Airheart 2.0	143	100-150 lbs. / 45-68 kg.	5-7	35.5-37.5	-	Med-Stiff	2,4kg / 5,2lbs	6.4	109.6	23.6	27.6	27.6	0	49	19.3	-	-
	146	100-150 lbs. / 45-68 kg.	6-8	36.5-38.5	-	Med-Stiff	2,5kg / 5,4lbs	6.6	112.2	23.8	27.9	27.9	0	49	19.3	-	-
	149	110-160 lbs. / 49-73 kg.	7-9	37.5-39.5	-	Med-Stiff	2,6kg / 5,6lbs	6.8	114.8	24	28.2	28.2	0	51	20.1	-	-
	152	110-160 lbs. / 49-73 kg.	8-9.5	38.5-40.5	-	Med-Stiff	2,7kg / 5,9lbs	7	117.4	24.2	28.5	28.5	0	51	20.1	-	-
	155	120-170 lbs. / 54-77 kg.	8-10	38.5-41.5	-	Med-Stiff	2,8kg / 6,1lbs	7.2	120	24.4	28.8	28.8	0	51	20.1	-	-
Women's Twin Sister	140	90-140 lbs. / 41-63 kg.	5-7	35.5-37.5	-	Medium	2,1kg / 4,7lbs	6.6	107.2	23.8	27.6	27.6	0	49	19.3	-	-
	143	100-150 lbs. / 45-68 kg.	6-8	36.5-38.5	-	Medium	2,2kg / 4,9lbs	6.8	109.8	24	27.9	27.9	0	51	20.1	-	-
	146	100-150 lbs. / 45-68 kg.	7-9	37.5-39.5	-	Medium	2,3kg / 5,1lbs	7	112.4	24.2	28.2	28.2	0	51	20.1	-	-
	149	110-160 lbs. / 49-73 kg.	8-9.5	38.5-40.5	-	Medium	2,4kg / 5,3lbs	7.2	115	24.4	28.5	28.5	0	53	20.9	-	-
	152	110-160 lbs. / 49-73 kg.	8-10	38.5-42	-	Medium	2,5kg / 5,6lbs	7.4	117.6	24.6	28.8	28.8	0	53	20.9	-	-
	155	120-170 lbs. / 54-77 kg.	8-11	38.5-43	-	Medium	2,7kg / 5,8lbs	7.6	120.2	24.8	29.0	29.0	0	53	20.9	-	-
Women's Rally Cat	139	90-140 lbs. / 41-63 kg.	5-6.5	35-37	-	Med-Soft	2,1kg / 4,6lbs	6	101	23.6	27.5	27.5	0	47	18.5	-	-
	142	90-140 lbs. / 41-63 kg.	5-7	35.5-37.5	-	Med-Soft	2kg / 4,5lbs	6.2	103.6	23.8	27.8	27.8	0	47	18.5	-	-
	145	100-150 lbs. / 45-68 kg.	6-8	36.5-38.5	-	Med-Soft	2,1kg / 4,7lbs	6.4	106.2	24	28.1	28.1	0	49	19.3	-	-
	148	100-150 lbs. / 45-68 kg.	6-8	36.5-38.5	-	Med-Soft	2,2kg / 4,9lbs	6.6	108.8	24.2	28.4	28.4	0	49	19.3	-	-
	151	110-160 lbs. / 49-73 kg.	7-9	37.5-39.5	-	Med-Soft	2,4kg / 5,2lbs	6.8	111.4	24.4	28.7	28.7	0	51	20.1	-	-
	154	120-170 lbs. / 54-77 kg.	8-10	38.5-42	-	Med-Soft	2,5kg / 5,4lbs	7	114	24.6	28.9	28.9	0	51	20.1	-	-
Women's Tweaker	 140	90-140 lbs. / 41-63 kg.	5-7	35.5-37.5	-	Med-Soft	2,1kg / 4,6lbs	6	108	23.2	27.8	27.8	0	48	18.9	-	-
	 143	90-140 lbs. / 41-63 kg.	5-7	35.5-37.5	-	Med-Soft	2,2kg / 4,9lbs	6.2	110.6	23.4	28.1	28.1	0	48	18.9	-	-
	 146	100-150 lbs. / 45-68 kg.	6-8	36.5-38.5	-	Med-Soft	2,3kg / 5,1lbs	6.4	113.2	23.6	28.4	28.4	0	50	19.7	-	-
	 149	100-150 lbs. / 45-68 kg.	6-8	36.5-38.5	-	Med-Soft	2,3kg / 5,2lbs	6.6	115.8	23.8	28.6	28.6	0	50	19.7	-	-
	 151	110-160 lbs. / 49-73 kg.	7-9	37.5-40	-	Med-Soft	2,4kg / 5,4lbs	7	117.4	24	28.7	28.7	0	52	20.5	-	-
Women's Solution	146	90-140 lbs. / 41-63 kg.	5-7	35.5-37.5	-	Med-Stiff	2,5kg / 5,5lbs	7.1	107.2	23.7	28.2	26.8	14.1	51	20.1	A	S
	149	100-150 lbs. / 45-68 kg.	6-8	36.5-38.5	-	Med-Stiff	2,6kg / 5,7lbs	7.3	109.8	23.9	28.5	27.1	14.1	53	20.9	A	S
	152	110-160 lbs. / 49-73 kg.	7-9	37.5-40.5	-	Med-Stiff	2,7kg / 5,9lbs	7.5	112.4	24.1	28.8	27.4	14	53	20.9	A	M
	155	120-170 lbs. / 54-77 kg.	8-10	38.5-41.5	-	Med-Stiff	2,8kg / 6,2lbs	7.8	115	24.3	29.0	27.6	13.8	53	20.9	A	M
Women's Howler Split	 148	110-160 lbs. / 49-73 kg.	7-10	37.5-41.5	-	Med-Stiff	2,6kg / 5,7lbs	7.6	114.3	24.5	28.8	28.0	8	51	20.1	A	M
	 151	110-160 lbs. / 49-73 kg.	8-11	39.5-43	-	Med-Stiff	2,7kg / 5,7lbs	7.8	116.9	24.7	29.1	28.3	8	53	20.9	A	M
Women's Stratos Split	146	100-150 lbs. / 45-68 kg.	6-8	36.5-38.5	-	Medium	2,6kg / 5,8lbs	6.3	107.8	23.9	28.7	27.7	10	51	20.1	A	S
	149	110-160 lbs. / 49-73 kg.	7-9	37.5-39.5	-	Medium	2,7kg / 5,9lbs	6.5	110.2	24.2	29.0	28.0	10	53	20.9	A	S
	152	110-160 lbs. / 49-73 kg.	8-10	38.5-41.5	-	Medium	2,8kg / 6,2lbs	6.7	112.8	24.4	29.3	28.3	10	53	20.9	A	M
Women's Dream Weaver 2.0 Split	145	90-140 lbs. / 41-63 kg.	6-8	36.5-38.5	-	Med-Soft	2,7kg / 5,9lbs	6.9	109.7	23.9	28.2	27.7	5	51	20.1	A	S
	148	100-150 lbs. / 45-68 kg.	6-8	36.5-38.5	-	Med-Soft	2,7kg / 6lbs	7.1	112.3	24.1	28.5	28.0	5	51	20.1	A	M
	151	110-160 lbs. / 49-73 kg.	7-9	37.5-39.5	-	Med-Soft	2,8kg / 6,2lbs	7.3	114.9	24.3	28.7	28.2	5	53	20.9	A	M
	154	120-170 lbs. / 54-77 kg.	8-10	38.5-42	-	Med-Soft	2,9kg / 6,4lbs	7.5	117.5	24.5	29.0	28.5	5	53	20.9	A	M

Board Specs

	Length (cm)	Weight range	Ideal boot size (Us men/women)	Ideal boot size (eur)	Big horn series	Flex	Board weight	Sidecut (m)	Effective edge length (cm)	Shaping waist width (cm)	Tip width (cm)	Tail width (cm)	Taper (mm)	Reference stance (cm)	Reference stance (in)	Skins group (pre-cut)	Skins group (trim-to-fit)
Flagship Junior	127	70-90 lbs. / 31-42 kg.	3.5-5	35-37	-	Med-Stiff	1.7kg / 3.7lbs	6	89.1	22.8	26.3	25.4	8.5	44	17.3	-	-
	132	75-120 lbs. / 34-54 kg.	3.5-5	35-37	-	Med-Stiff	1.8kg / 4lbs	6.3	93.7	23.2	26.9	26.1	8.2	46	18.1	-	-
	137	90-140 lbs. / 41-63 kg.	4-6	35.5-38	-	Med-Stiff	2kg / 4.4lbs	6.6	98.3	23.6	27.5	26.7	8.3	48	18.9	-	-
	142	100-150 lbs. / 45-68 kg.	5-7	37-39.5	-	Med-Stiff	2.2kg / 4.9lbs	6.9	102.9	24	28.1	27.3	8.3	50	19.7	-	-
	147	110-150 lbs. / 50-68 kg.	5-7	37-39.5	-	Med-Stiff	2.3kg / 5.1lbs	7.2	107.5	24.4	28.6	27.8	8.3	52	20.5	-	-
Mountain Twin Junior	120	65-85 lbs. / 29-39 kg.	2-4.5	33-36	-	Medium	1.6kg / 3.5lbs	5.5	86	22.8	25.8	25.8	0	42	16.5	-	-
	125	70-90 lbs. / 31-42 kg.	2-4.5	34-36	-	Medium	1.7kg / 3.7lbs	5.8	90.7	23.1	26.3	26.3	0	44	17.3	-	-
	130	75-100 lbs. / 34-45 kg.	3.5-5	35-37	-	Medium	1.8kg / 4lbs	6.1	95.4	23.4	26.8	26.8	0	46	18.1	-	-
	135	80-110 lbs. / 36-50 kg.	4-6	35.5-38	-	Medium	1.9kg / 4.2lbs	6.4	100.1	23.7	27.3	27.3	0	48	18.9	-	-
	140	90-120 lbs. / 41-54 kg.	5-7	37-39.5	-	Medium	2.1kg / 4.6lbs	6.7	104.8	24	27.8	27.8	0	50	19.7	-	-
	145	100-150 lbs. / 45-71 kg.	5-7	37-39.5	-	Medium	2.3kg / 5.1lbs	7	109.5	24.3	28.2	28.2	0	52	20.5	-	-
Twin Sister Junior	120	65-85 lbs. / 29-39 kg.	2-4.5	33-36	-	Medium	1.6kg / 3.5lbs	5.5	86	22.8	25.8	25.8	0	42	16.5	-	-
	125	70-90 lbs. / 31-42 kg.	2-4.5	34-36	-	Medium	1.7kg / 3.7lbs	5.8	90.7	23.1	26.3	26.3	0	44	17.3	-	-
	130	75-100 lbs. / 34-45 kg.	3.5-5	35-37	-	Medium	1.8kg / 4lbs	6.1	95.4	23.4	26.8	26.8	0	46	18.1	-	-
	135	80-110 lbs. / 36-50 kg.	4-6	35.5-38	-	Medium	1.9kg / 4.2lbs	6.4	100.1	23.7	27.3	27.3	0	48	18.9	-	-
Kids Prodigy Package	80	24-40 lbs. / 11-18 kg.	7C-12C	24-30.5	-	Med-Soft	1.8kg / 4lbs	3.3	48	18	19.5	19.5	0	30	11.8	-	-
	90	30-53 lbs. / 14-24 kg.	7C-12C	24-30.5	-	Med-Soft	1.9kg / 4.2lbs	4.1	57	19	20.7	20.7	0	32	12.6	-	-
	100	45-65 lbs. / 20-29 kg.	10C-1.5	27-32.5	-	Med-Soft	1.9kg / 4.2lbs	5.1	67	20	22.1	22.1	0	36	14.2	-	-
Youth Prodigy	80	24-40 lbs. / 11-18 kg.	7C-12C	24-30.5	-	Med-Soft	1kg / 2.2lbs	3.3	48	18	19.5	19.5	0	30	11.8	-	-
	90	30-53 lbs. / 14-24 kg.	7C-12C	24-30.5	-	Med-Soft	1.1kg / 2.4lbs	4.1	57	19	20.7	20.7	0	32	12.6	-	-
	100	45-65 lbs. / 20-29 kg.	10C-1.5	27-32.5	-	Med-Soft	1.1kg / 2.4lbs	5.1	67	20	22.1	22.1	0	36	14.2	-	-
	110	55-75 lbs. / 25-34 kg.	12C-2	30.5-33	-	Med-Soft	1.3kg / 2.9lbs	5.4	76	21	23.5	23.5	0	38	15	-	-
	115	55-85 lbs. / 25-39 kg.	1.5-3	32.5-34	-	Med-Soft	1.5kg / 3.2lbs	5.5	80.5	21.5	24.3	24.3	0	40	15.7	-	-
	120	65-85 lbs. / 29-39 kg.	2-4.5	33-36	-	Med-Soft	1.5kg / 3.4lbs	5.7	85	22	25.1	25.1	0	42	16.5	-	-
	125	70-90 lbs. / 31-42 kg.	2-4.5	34-36	-	Med-Soft	1.7kg / 3.7lbs	5.85	89.5	22.5	25.8	25.8	0	44	17.3	-	-
	130	75-100 lbs. / 34-45 kg.	3.5-5	35-37	-	Med-Soft	1.8kg / 4lbs	6	94	23	26.6	26.6	0	46	18.1	-	-
	135	80-110 lbs. / 36-50 kg.	4-6	35.5-38	-	Med-Soft	2kg / 4.3lbs	6.15	98.5	23.5	27.3	27.3	0	48	18.9	-	-
	140	90-120 lbs. / 41-54 kg.	5-7	37-39.5	-	Med-Soft	2.1kg / 4.7lbs	6.3	103	24	28.1	28.1	0	50	19.7	-	-
	145	100-150 lbs. / 45-71 kg.	5-7	37-39.5	-	Med-Soft	2.3kg / 5.1lbs	6.45	107.5	24.5	28.9	28.9	0	52	20.5	-	-
Kids Happy Mountain Package	90	25-55 lbs. / 11-25 kg	7C-12C	24-30.5	-	Soft	0.85kg / 1.9lbs	3	58	20	22.6	22.6	-	34	13.4	-	-
Kids Happy Mountain	90	25-55 lbs. / 11-25 kg	7C-12C	24-30.5	-	Soft	1.6kg / 3.5lbs	3	58	20	22.6	22.6	-	34	13.4	-	-
Solution Junior	137	90-140 lbs. / 41-63 kg.	4-6	35.5-38	-	Med-Stiff	2.2kg / 4.8lbs	6.6	98.3	23.6	27.5	26.7	8.3	48	18.9	-	S
	142	100-150 lbs. / 45-68 kg.	5-7	37-39.5	-	Med-Stiff	2.5kg / 5.5lbs	6.9	102.9	24	28.1	27.3	8.3	50	19.7	-	S
	147	110-150 lbs. / 50-68 kg.	5-8	37-40.5	-	Med-Stiff	2.6kg / 5.7lbs	7.2	107.5	24.4	28.6	27.8	8.3	52	20.5	-	S

Product specifications and prices may be subject to change without prior notice.





JONES

ART & LOOK

GO FASTER!

ELECTRIC

PROUD MEMBER OF
1% FOR THE PLANET
POW

Jimmy & Peter Goodman © Andrew Miller
Cover: Cass Jones © Fabian Bodet - Chamonix, France