

IPO and SELECT
Binding Manual

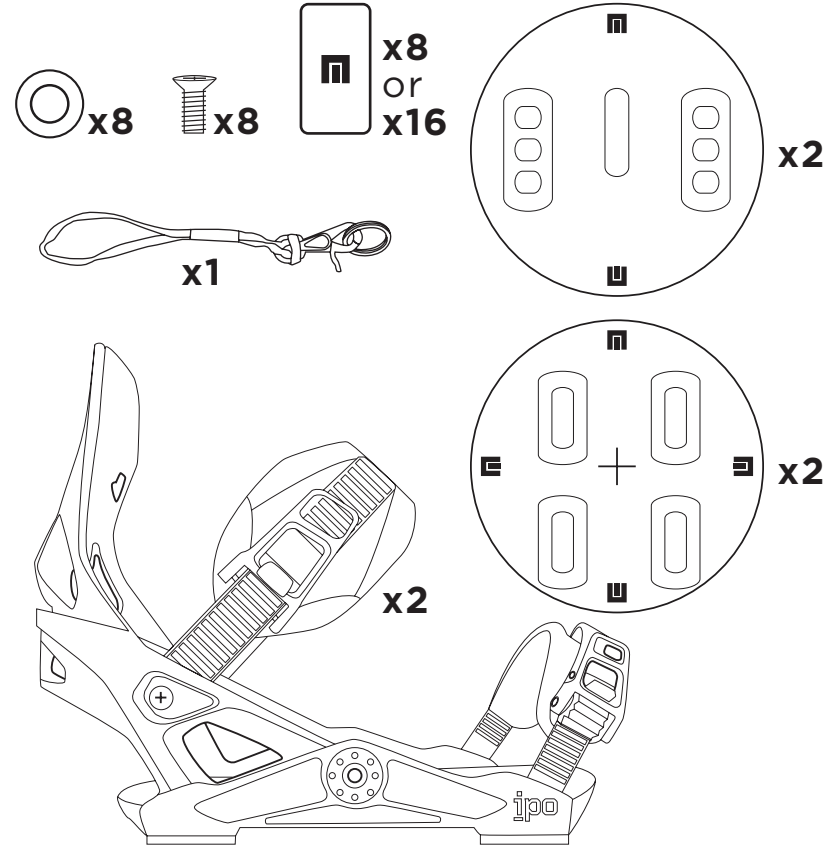



Thanks for purchasing Now bindings. This is the revolutionary snowboard binding design inspired by the dynamics of a skateboard truck. These bindings will provide unparalleled performance and comfort if properly set up. To get the most out of your bindings, please take the time to read over this manual to learn how to customize them to suit your needs and style.



***Phillips #3 screwdriver needed for binding installation.**

Opening the Foot Pillow

To open your Foot Pillow, grab the soft EVA pad at the heel and pull upward. Carefully read the instructions provided on the disc cover before mounting your bindings onto your board.

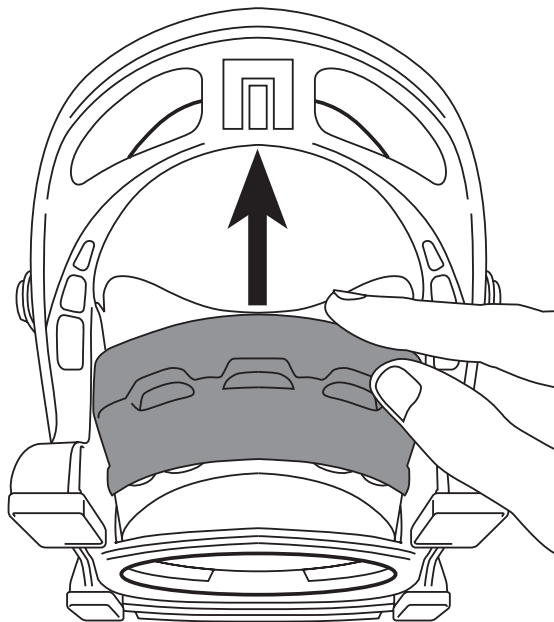

4x4 Hole Pattern Disc and EST Channel Disc

IMPORTANT: Note that on the 4X4 disc, the slotted holes are offset for strength and durability. You may have to flip your disc around in order to reach desire stance. The Cross in the middle indicate center of disc, please use that as a reference.

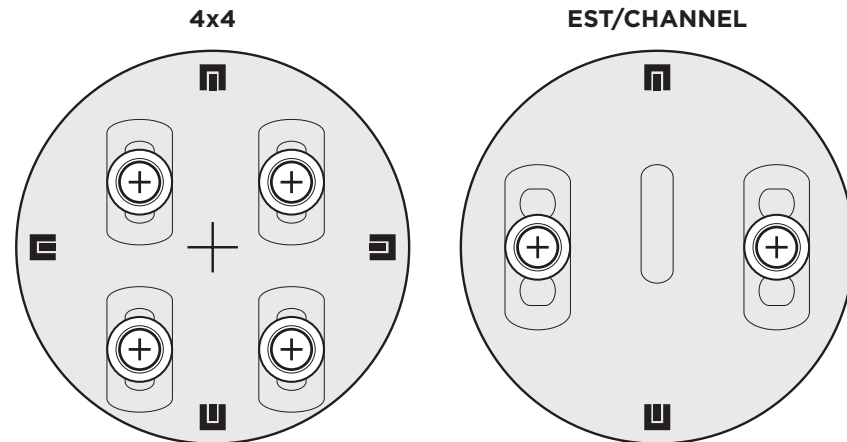

PLEASE NOTE: Slotted holes are offset from disc center marked with a +

Disc Orientation Options

Stance Width Adjustment

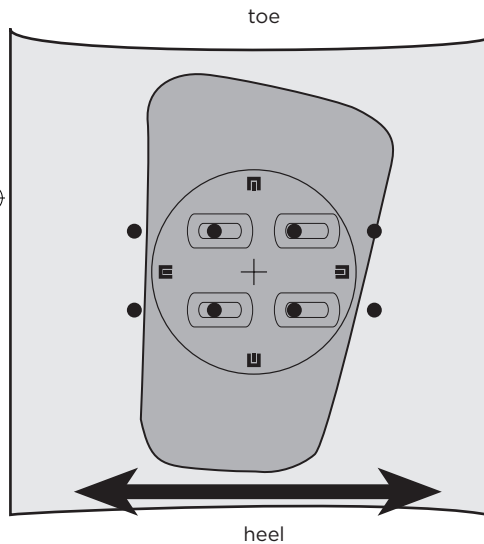

Boot Size Adjustment

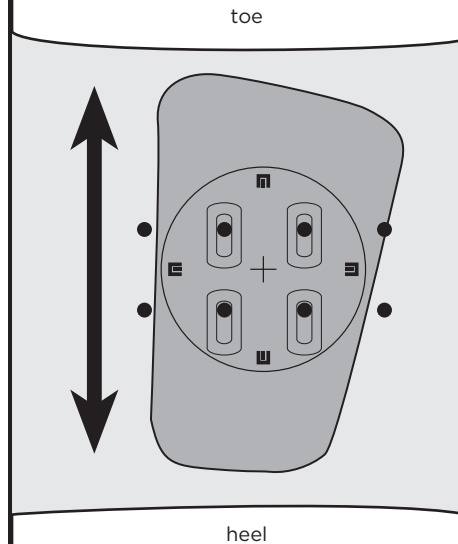

SMALL BINDING:

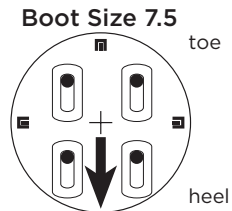
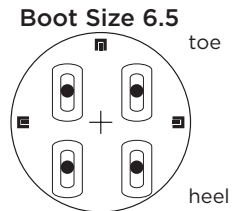
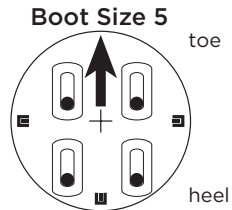

MEDIUM BINDING:

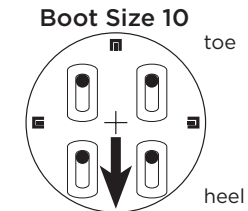
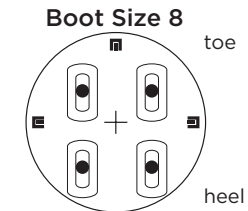
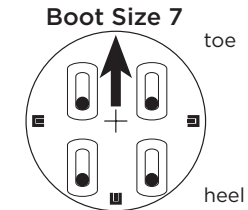

LARGE BINDING:

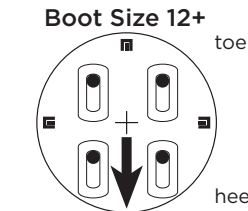
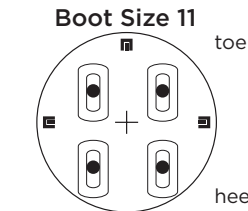
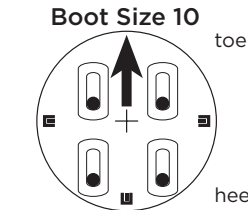

Toe and Heel Boot Size Adjustment Chart

All snowboard boots are not alike, so please check your settings and make sure that your boot is centered across your board.

Straps Adjustments

To adjust, simply open the tool-free NOW lever. Unscrew it, move straps to desired location, tighten, and close the tool-free NOW lever.

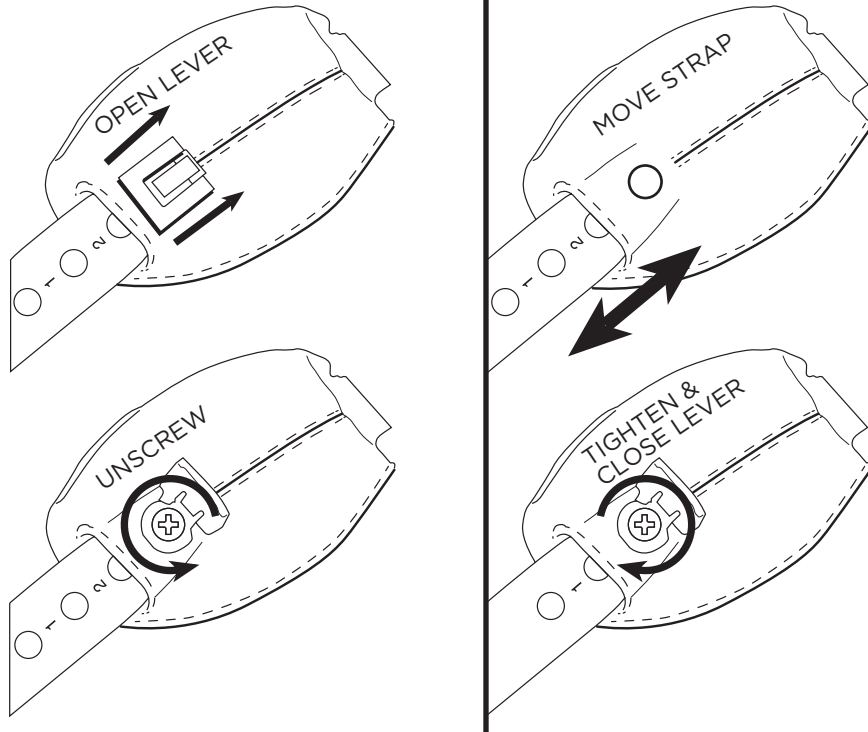

Toe Strap Placement

The toe cap strap is designed to be positioned and centered at the tip of your boots. To adjust please follow the same instructions as straps adjustments on previous page.

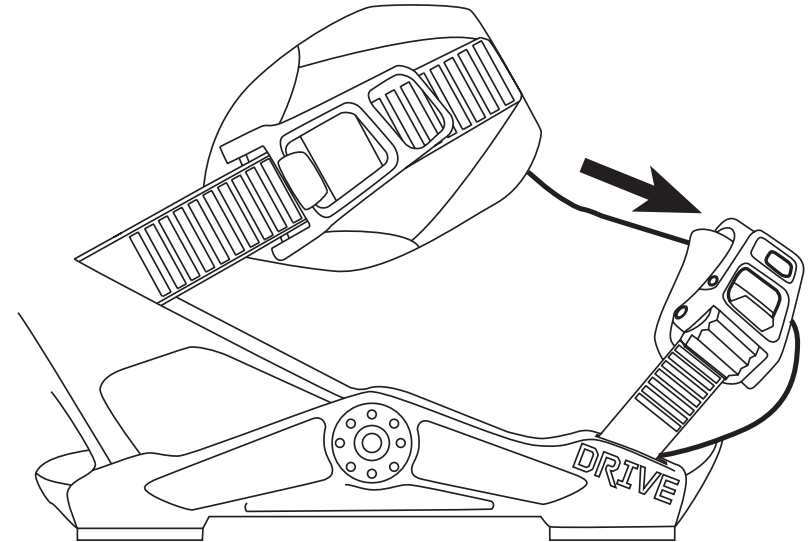

NoBack mode with HighCups.

Step 1: Remove highback by removing hardware on both sides with a phillips #3 and a 4mm allen key.

Step 2: Replace HighBack with HighCup and re-install the hardware. *Note: make sure that the t-nuts are properly fitted in the binding cavity and use a 4mm allen key to hold the t-nuts in their place.*

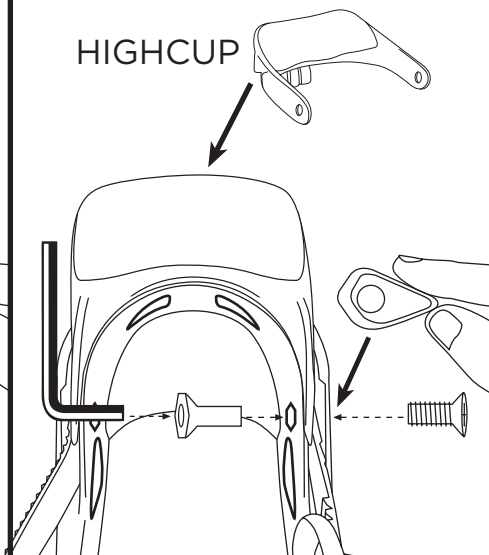
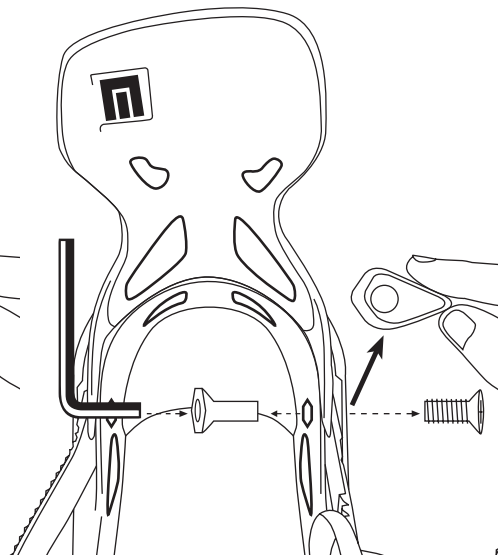

Forward Lean Adjustment

To change your forward lean, simply pull down the lever and move the forward lean block either up or down. When you reach the desired position, simply flip the lever back to the locked position.

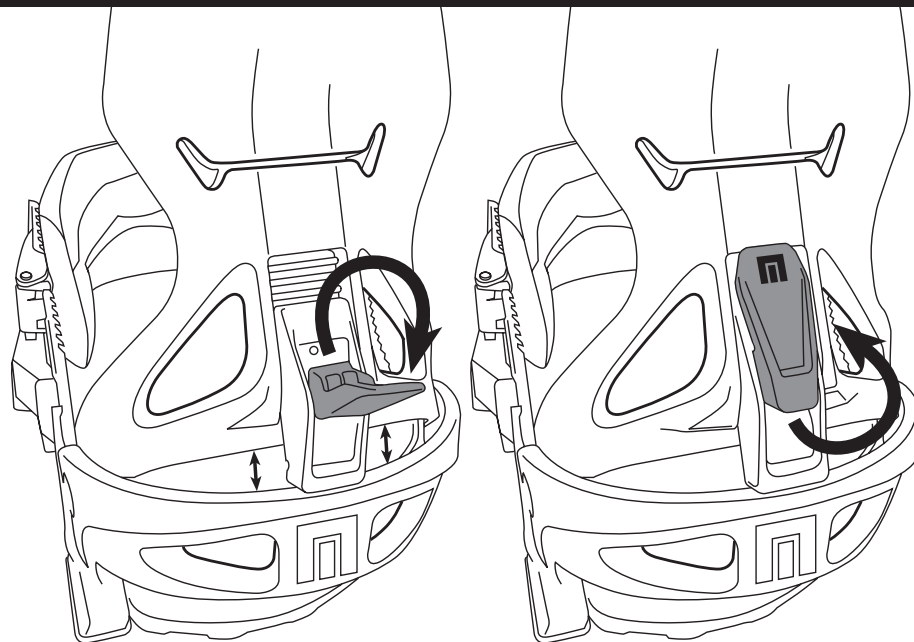

Closing the Foot Pillow

To close the foot pillow, simply push down on the EVA while the other hand is on the heelcup pulling upwards. You will hear a CLICK on both sides when the foot pillow is properly closed.

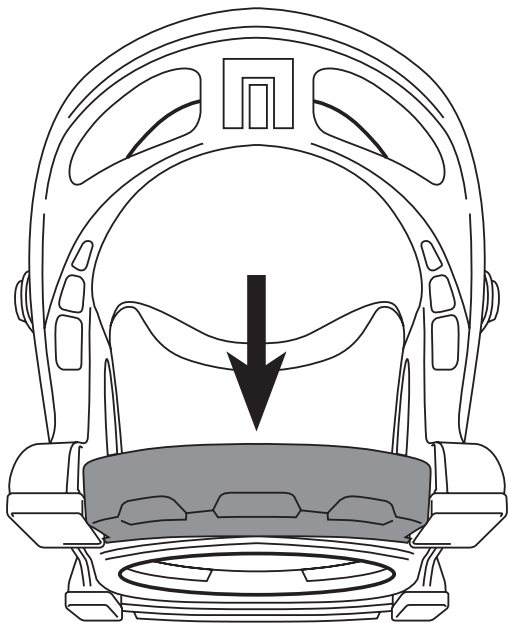

Custom Bushing Options

Now IPO and Select bindings come assembled with the Medium bushings. These bushings can be changed depending on your style of riding, snow conditions, weight or personal preference. To remove the bushings simply pop them out with your finger. Toe and heel bushings are different, so check the underside label before installing.

IMPORTANT: IPO bindings are sold with the Soft and Medium bushings only, for more bushing options please visit the NOW online store or go to a NOW authorized dealer.

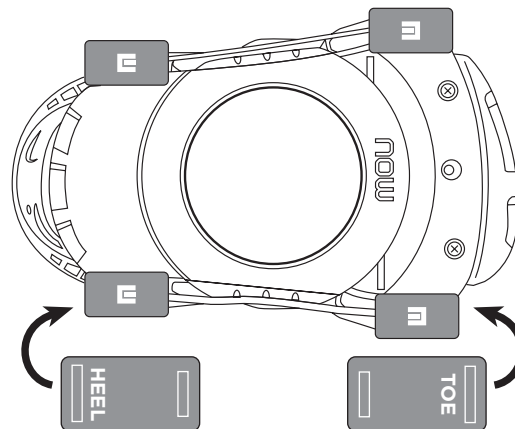

*Three Bushing Densities

SOFT (45 shore)
MEDIUM (50 shore)
HARD (60 shore)

*Sold with Medium and Hard Bushings



Warranty

Now Snowboarding offers to the original purchaser a lifetime warranty on the baseplate components (Hanger, Nylon-ring and Nylon disc), along with a one year limited warranty on all other parts. This warranty is not transferable, and Now reserves the right to repair or replace the faulty parts at its own discretion.

**For more information visit our warranty policy at:
now-snowboarding.com**

RIDERS, BE ADVISED: Snowboarding is a hazardous sport, which can result in serious injury or death to yourself or others. Use these Now bindings at your own risk. Check and tighten hardware before each use. Use only snowboard specific boots. Read this instruction manual when installing your Now bindings and before use. This binding does not release on impact. A runaway snowboard is a dangerous object and it can cause serious injuries or death – you are responsible so be aware. In compliance with ISO code 14573, you are required to wear a leash at all times. The leash must be attached to your bindings baseplate and securely fastened to your body.



What is “Skate-Tech”? Inspired by how easily and efficiently a skateboard turns; major components of our system mimic both the function and description of skateboard trucks. The ‘Hanger’ powerfully transfers energy input from the straps to the bushings and onto the edges of your board. The Kingpin acts as a fulcrum, magnifying this energy through leverage. Traditional bindings diminish energy transfer by the flexing and bending of their baseplate, forcing you to crank your straps down harder, ride with more forward lean, or run taller and stiffer highbacks. This all leads to more foot fatigue and pain. NOW bindings bypass the middle of the snowboard and direct your energy right onto the board’s edges. They simply transfer more power to the board with less work, meaning your feet will stay more relaxed and comfortable, longer.



RETHINK YOUR RIDE



Twitter: @nowbindings
Instagram: @nowbindings
Facebook: /nowsnowboarding
www.now-snowboarding.com

